

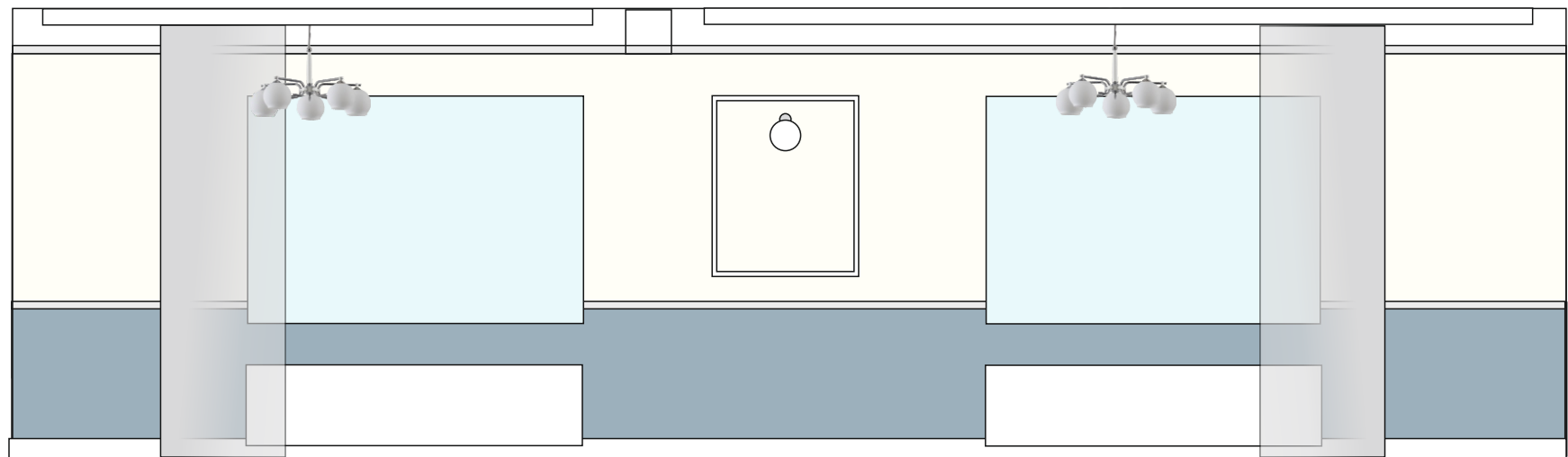

PROJEKT ŚWIETLICY W WOLI MAŁOWANEJ
Lech Janas
2021

RYSUNEK POGLĄDOWY

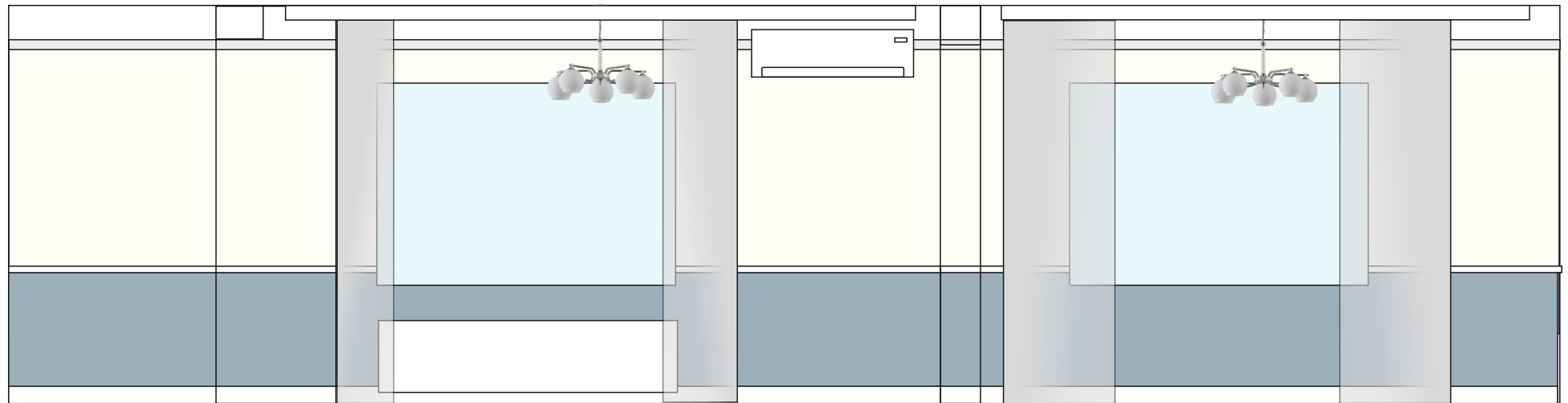

RYSUNEK POGLĄDOWY

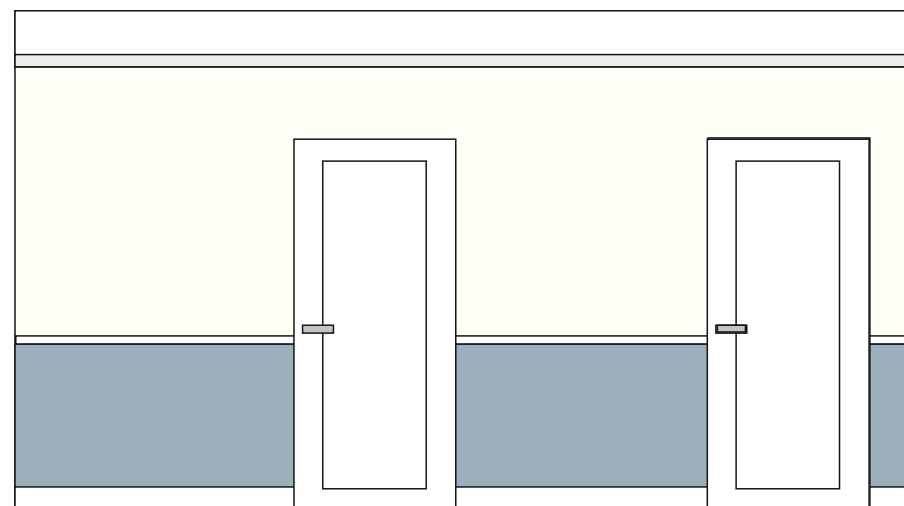
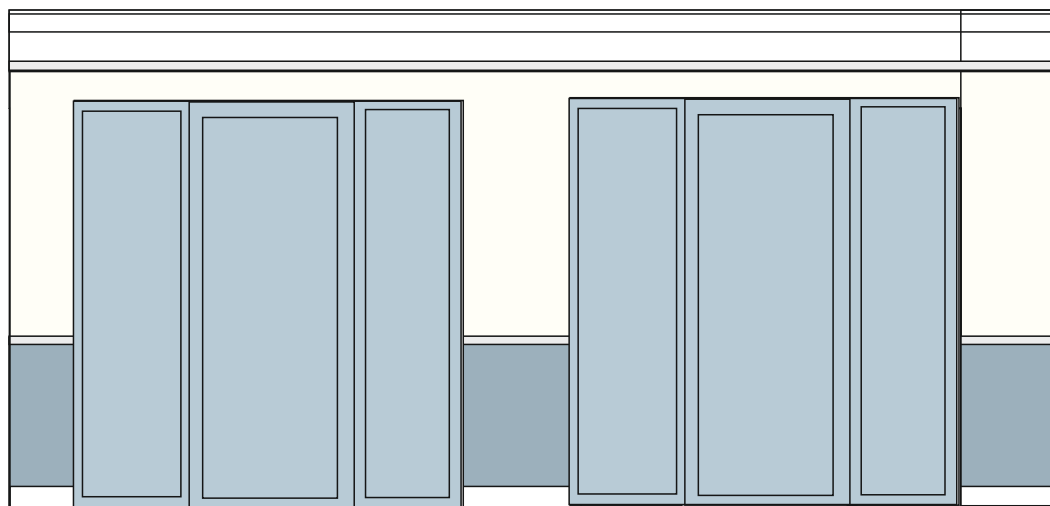
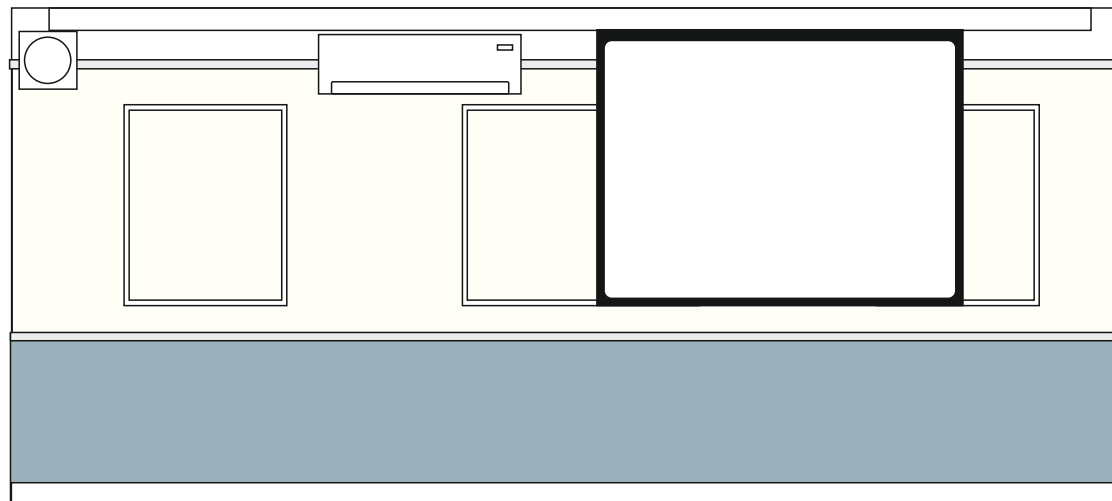

FUNKCJE

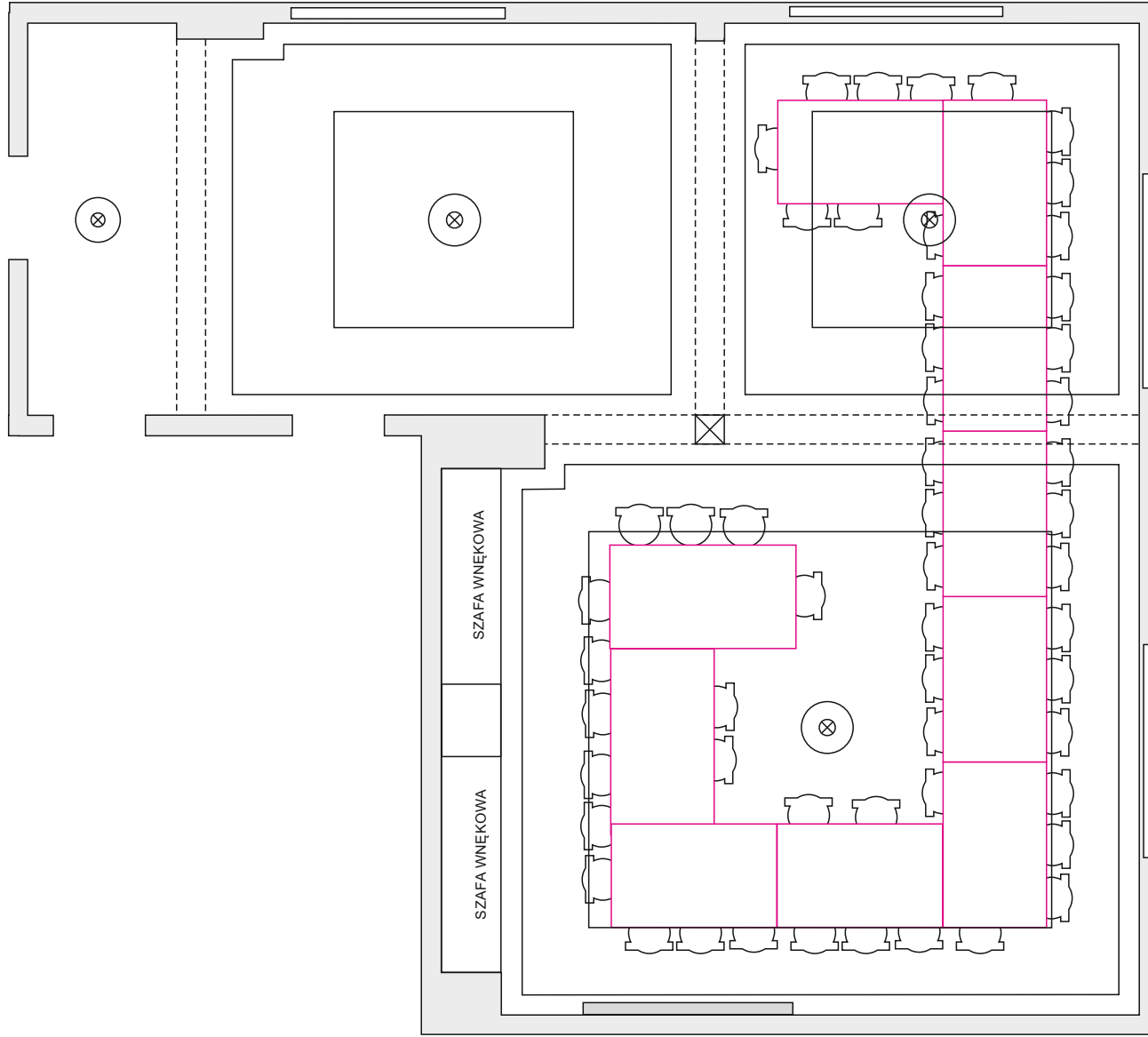

PROPOZYCJA SZTUKATERII

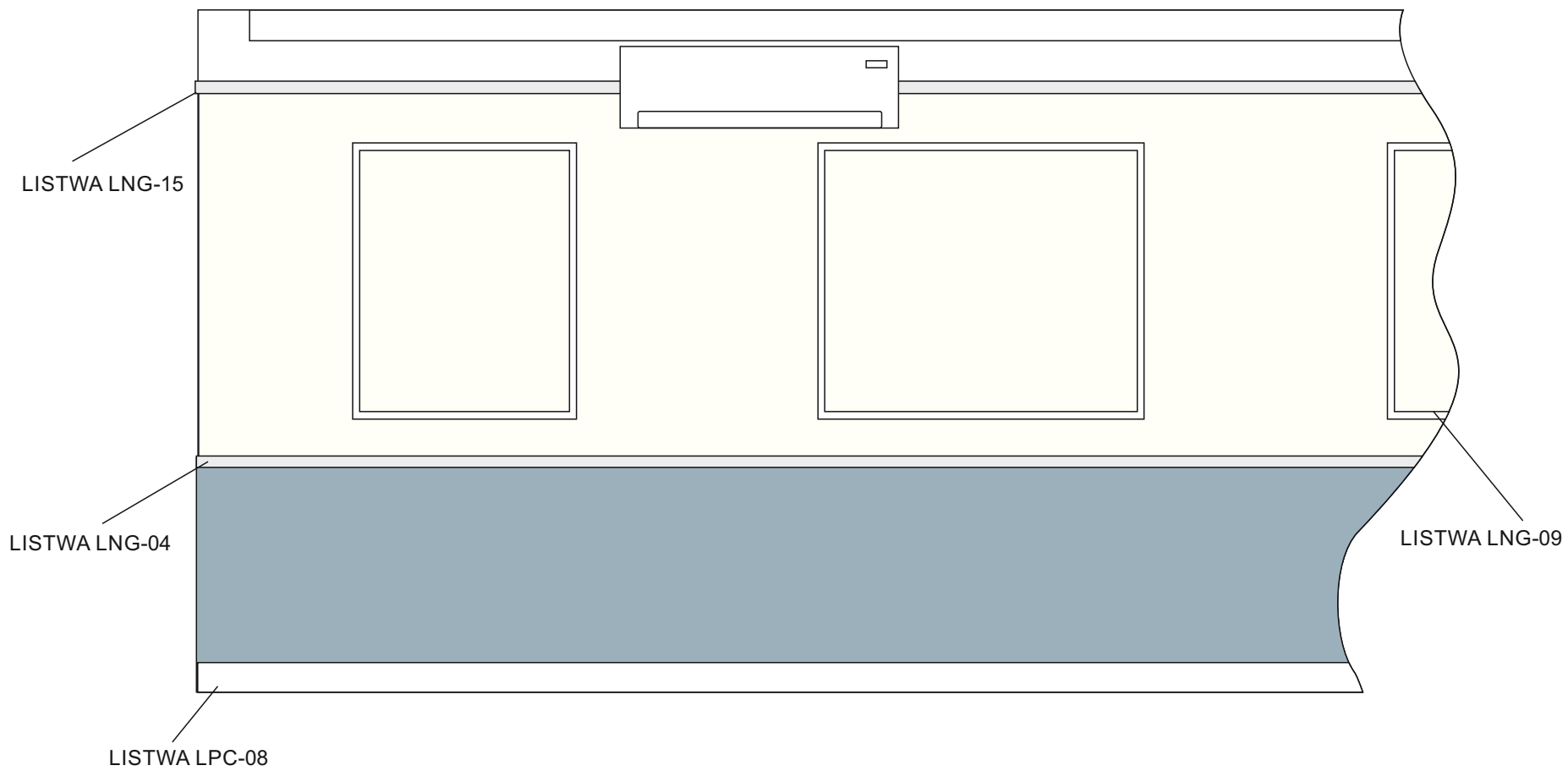

PODZIAŁ KOLORÓW

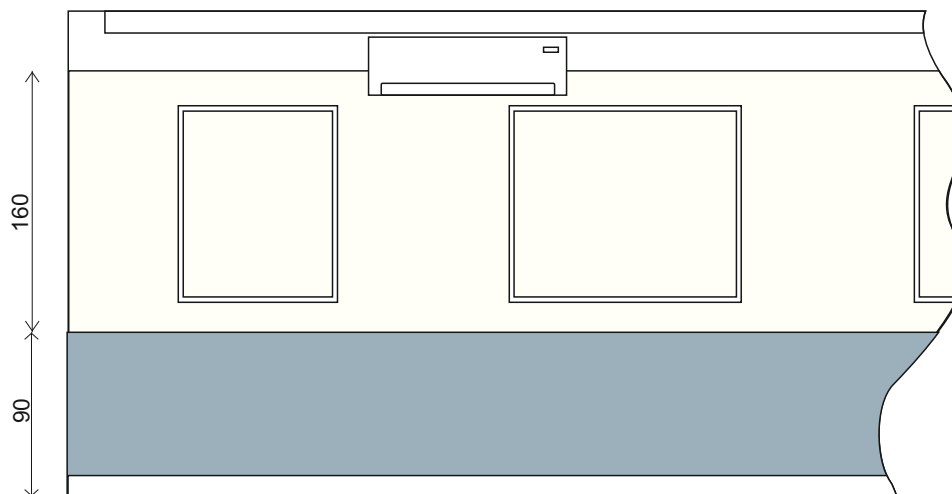
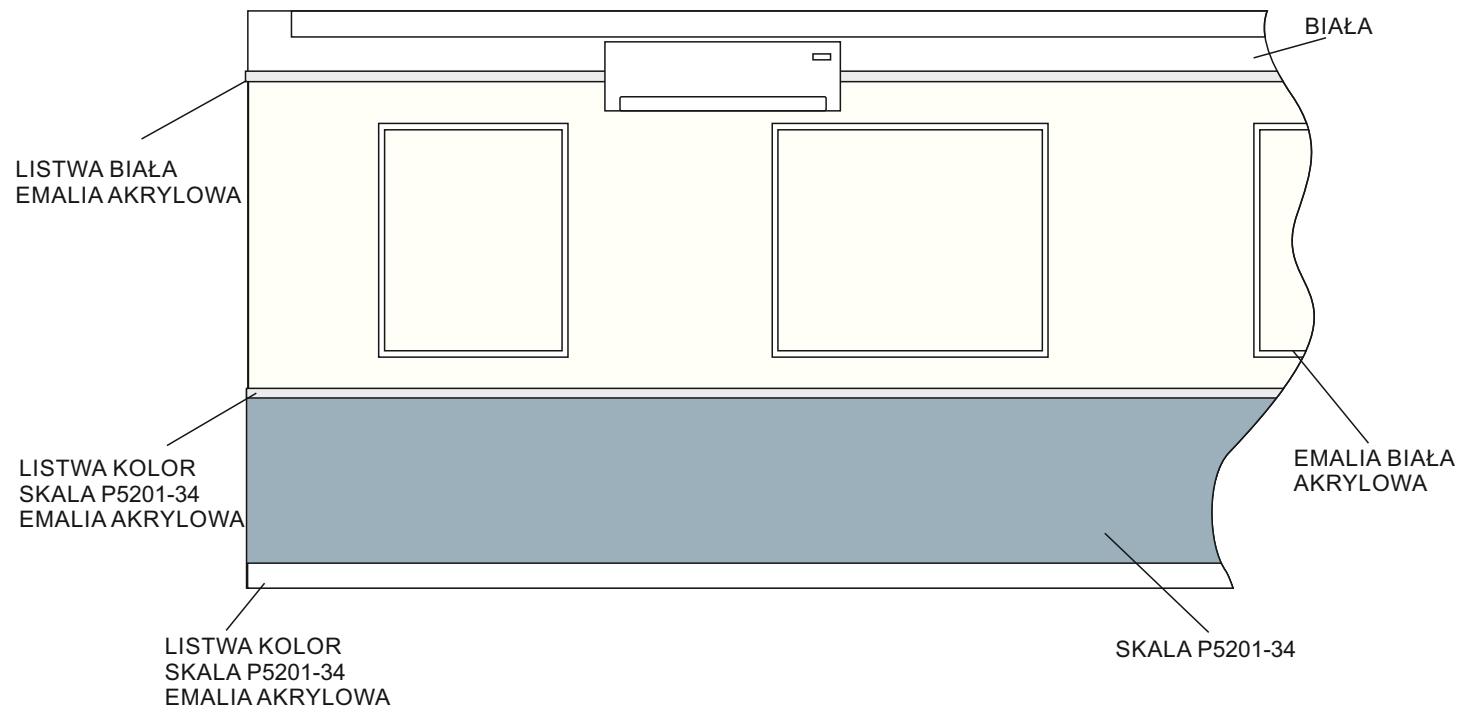

SZTUKATERIA - POŁOŻENIE LISTEW

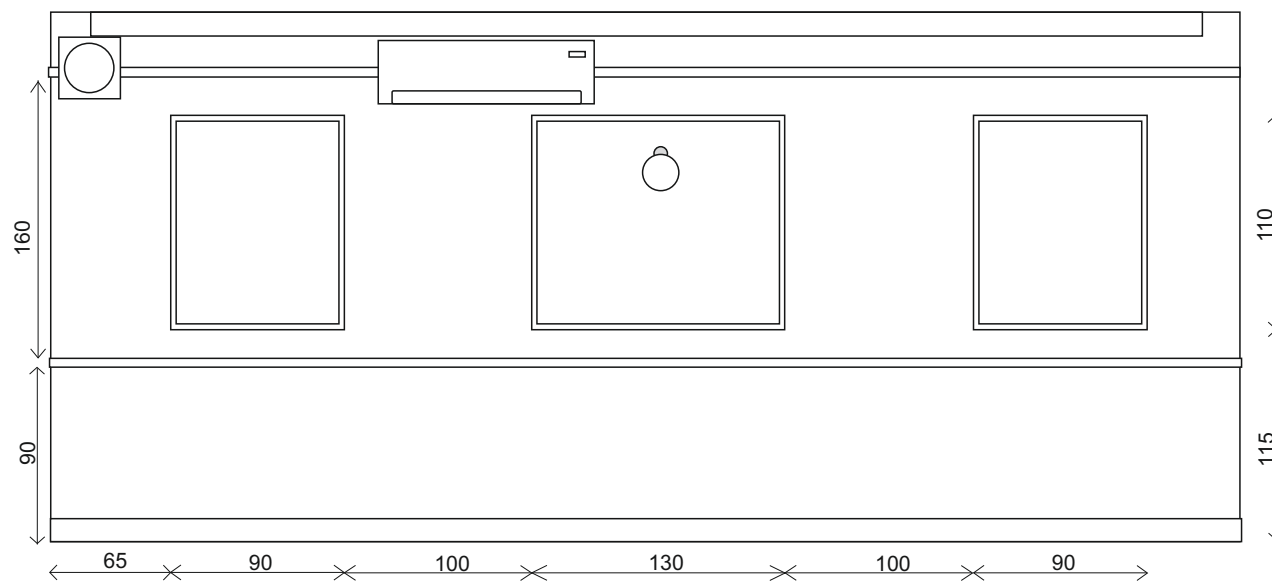
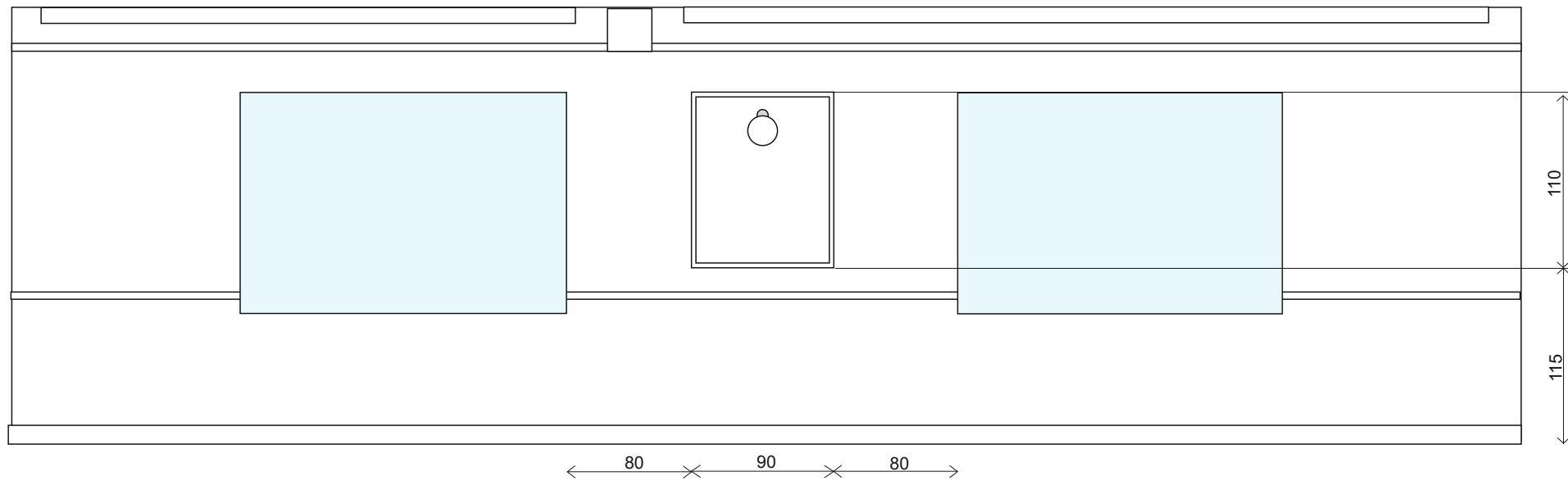

INSTALACJA AV

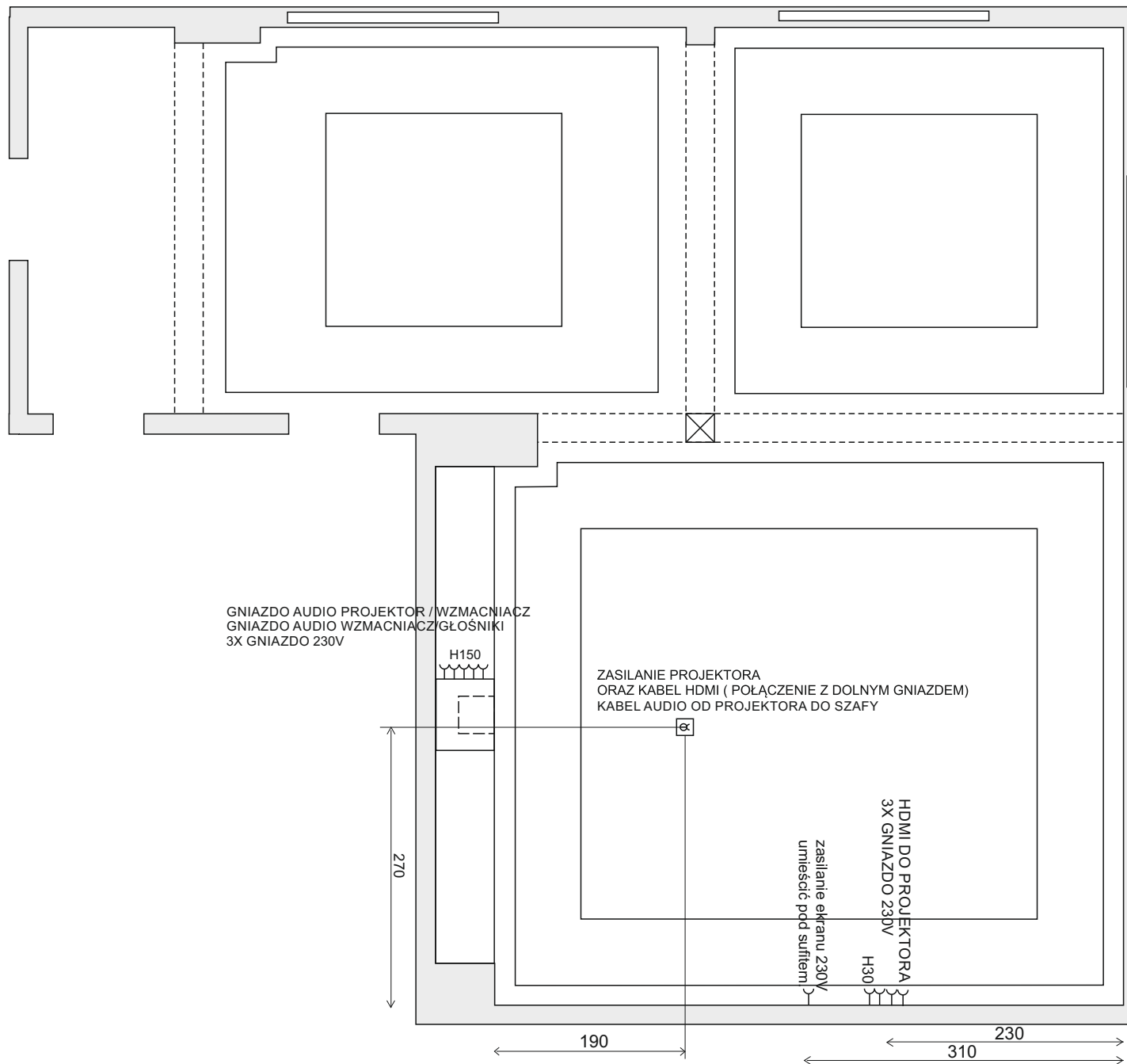

INSTALACJA NAGŁOŚNIENIA

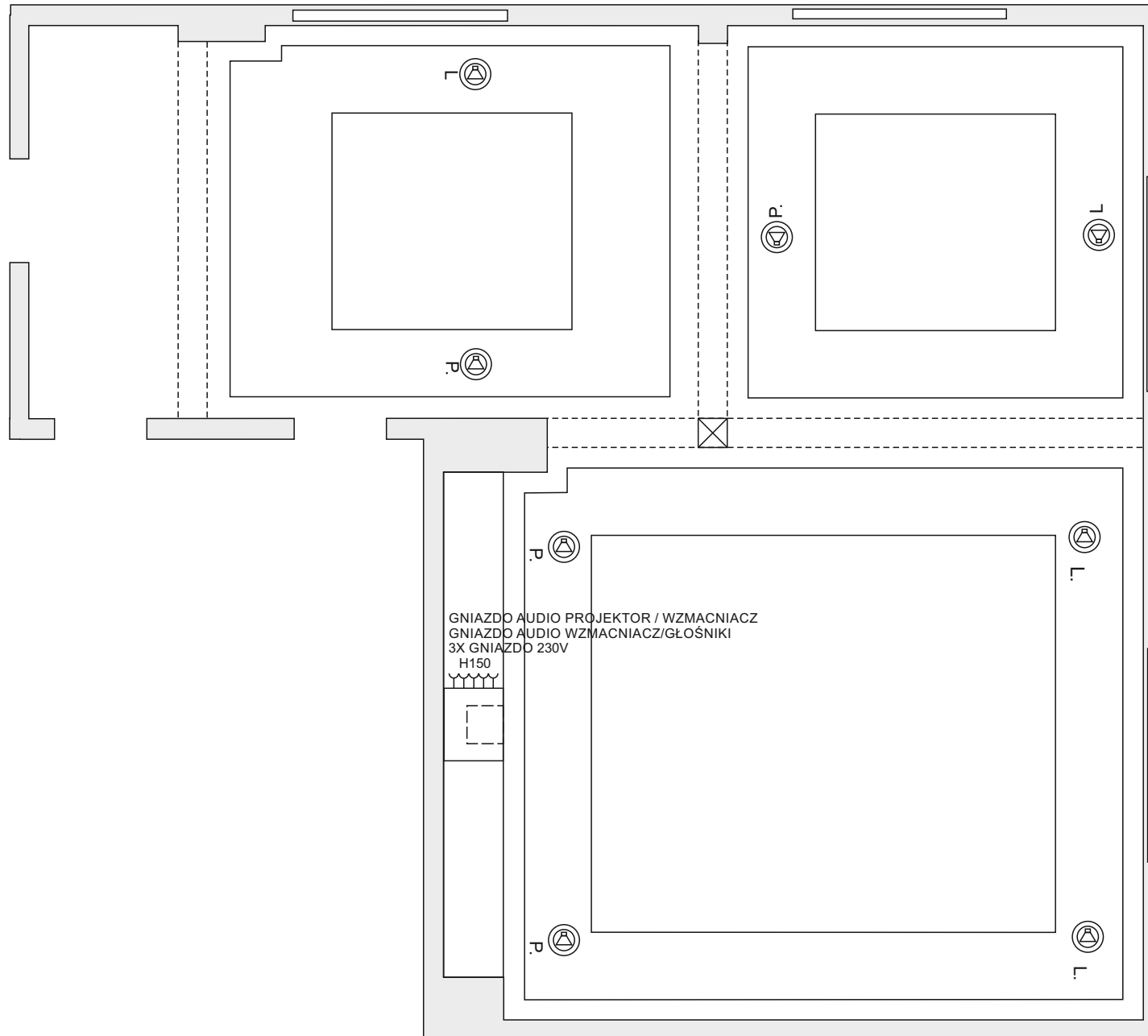

OŚWIETLENIE SUFITOWE

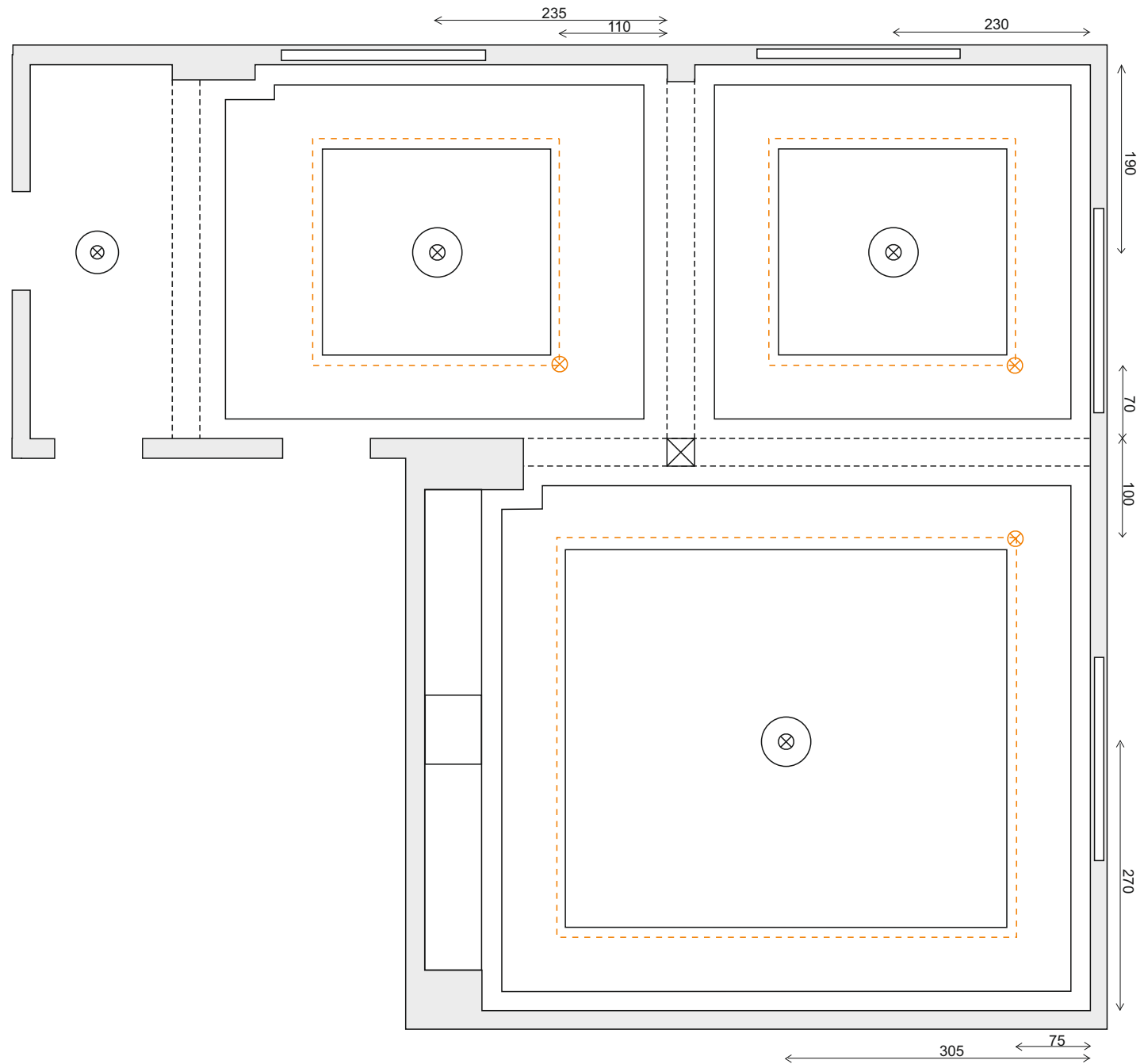

SUFITY PODWIESZANE

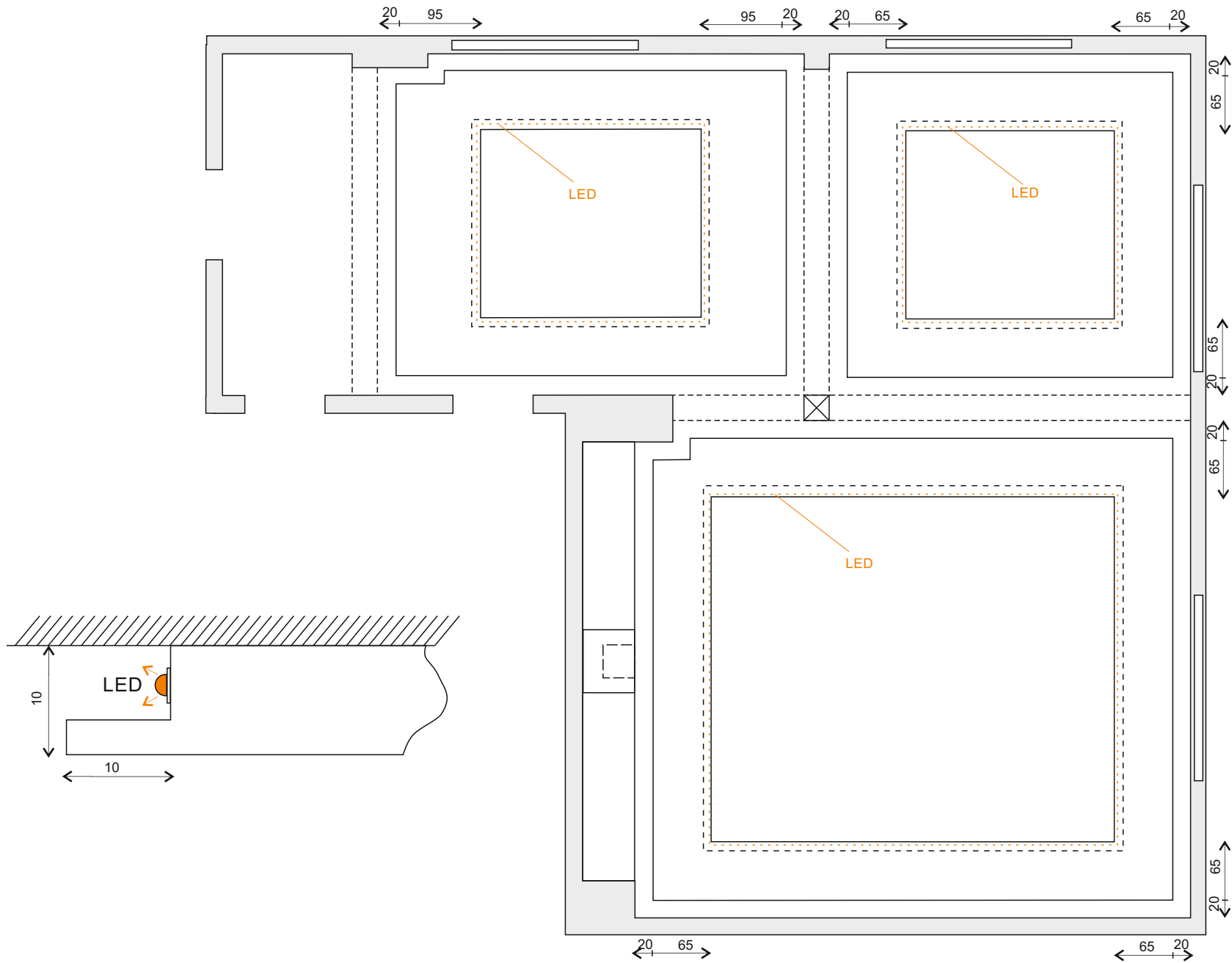

OŚWIETLENIE ŚCIENNE

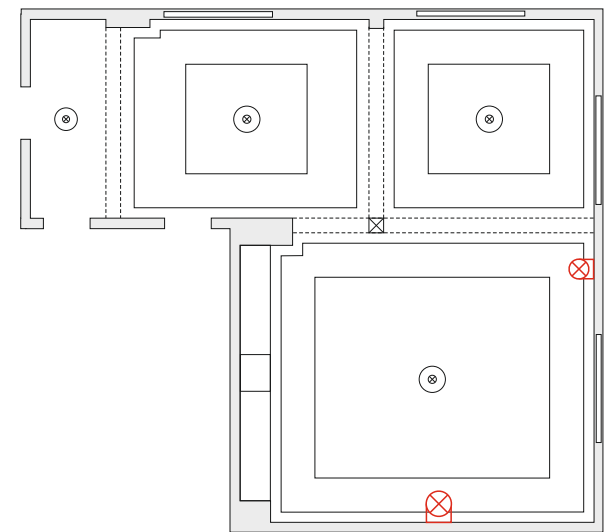
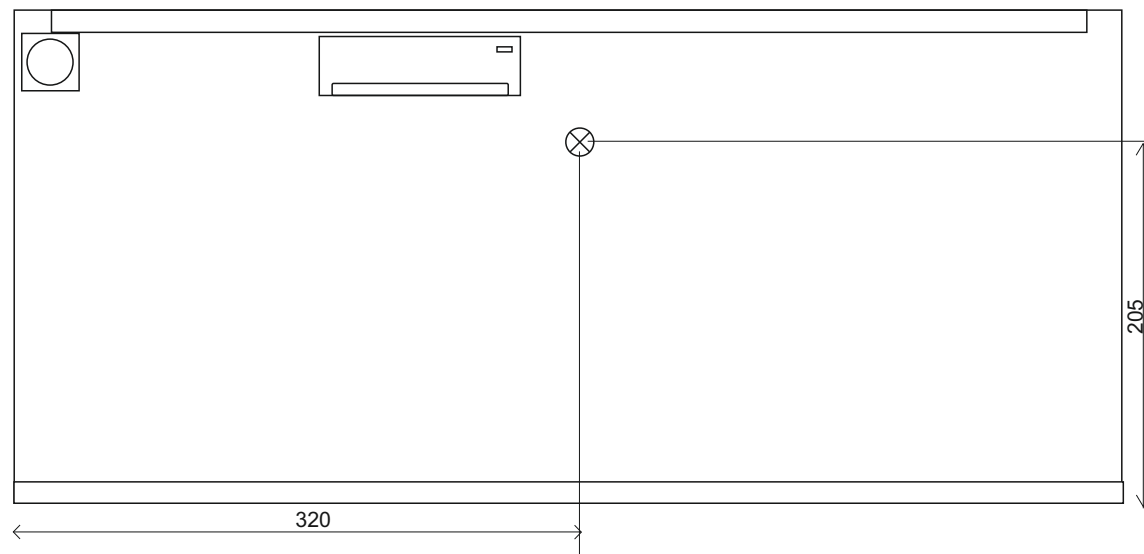
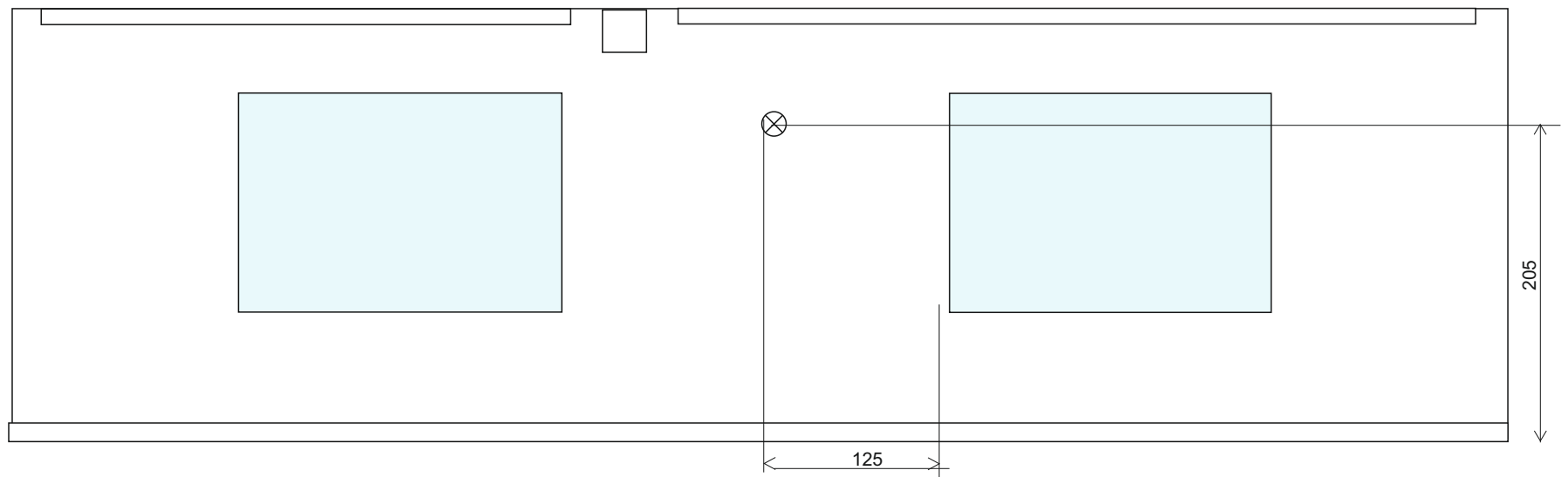

SYSTEM KARNISZY ZS CREATIVA

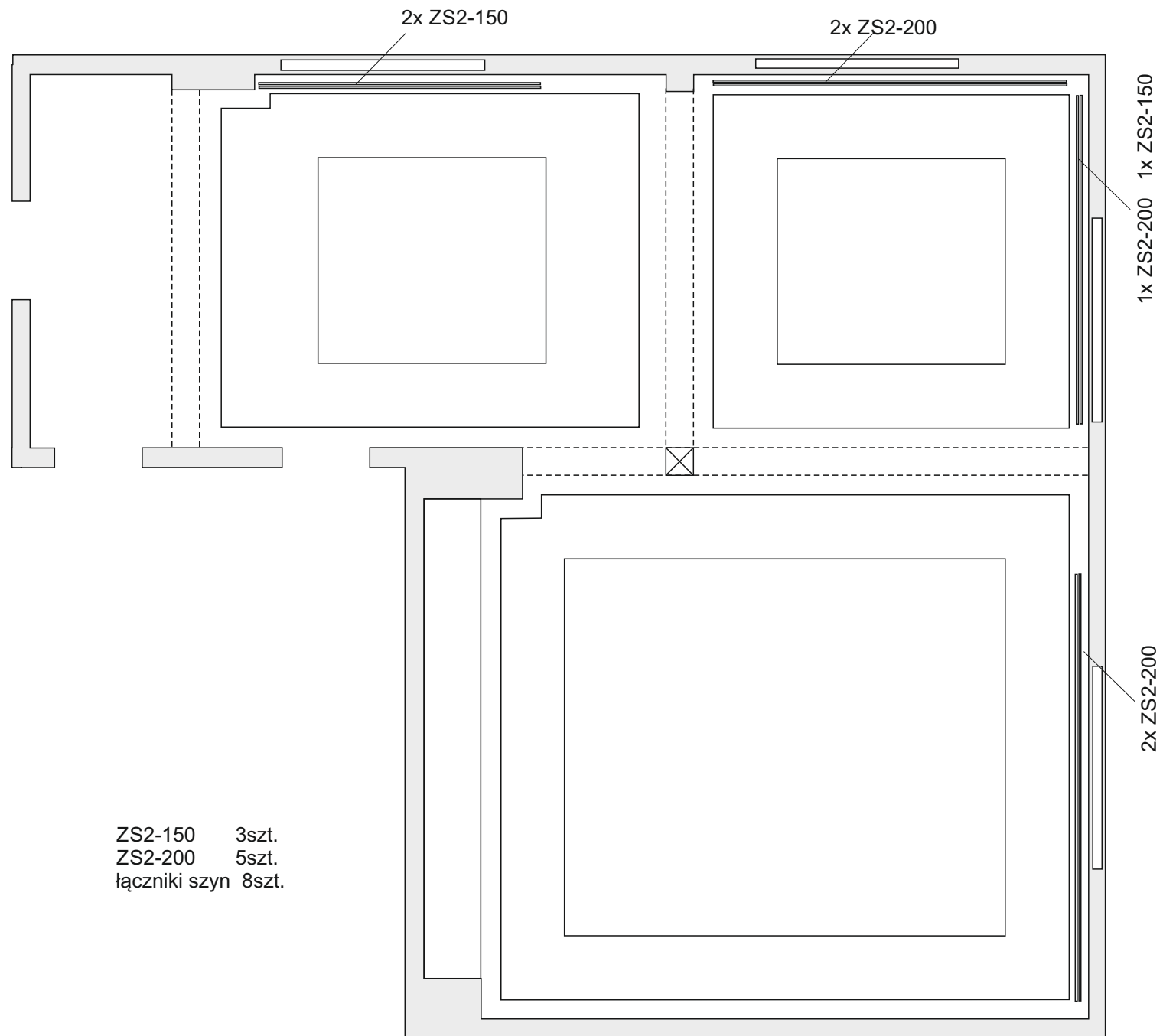

ZABUDOWA SZAFY WNEKOWEJ

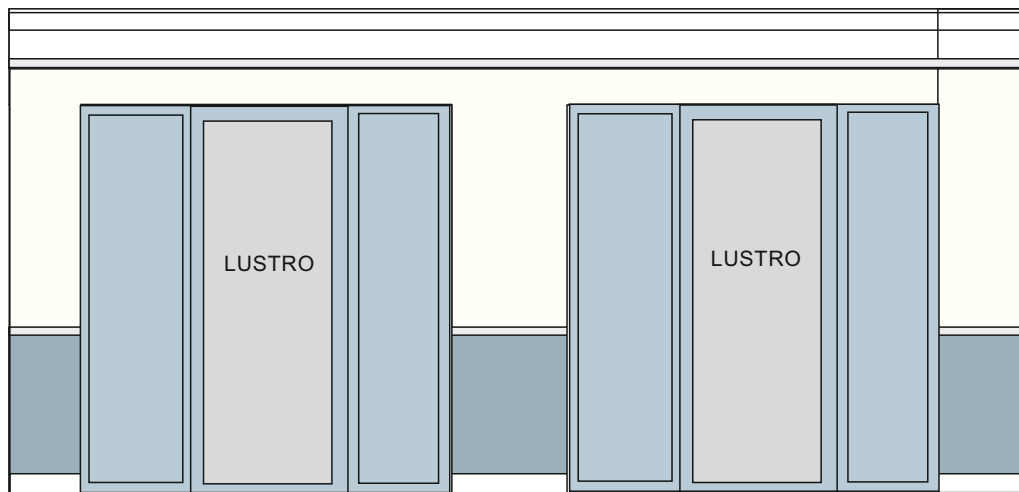

ZABUDOWA GK

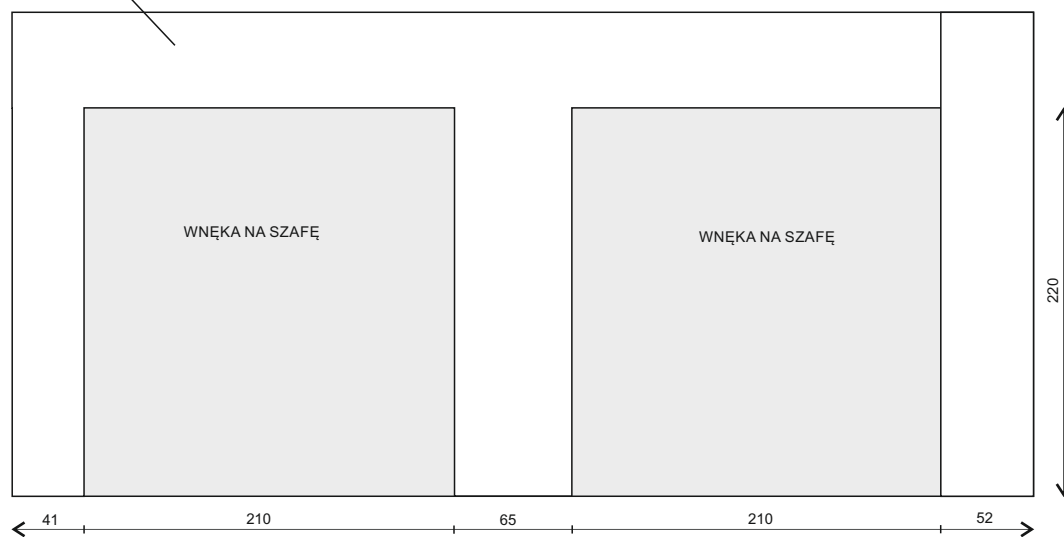

SZAFA WNĘKOWA PRZESUWNA

Drzwi wykonane z płyty kronospan 7179BS + lustra, drzwi gładkie lub ramiak lakierowany.

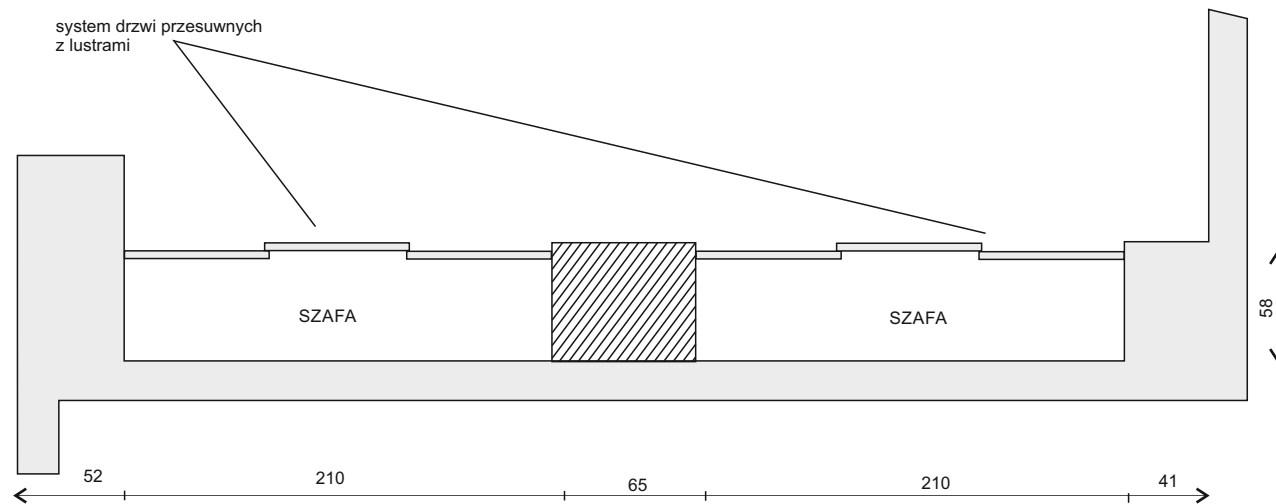
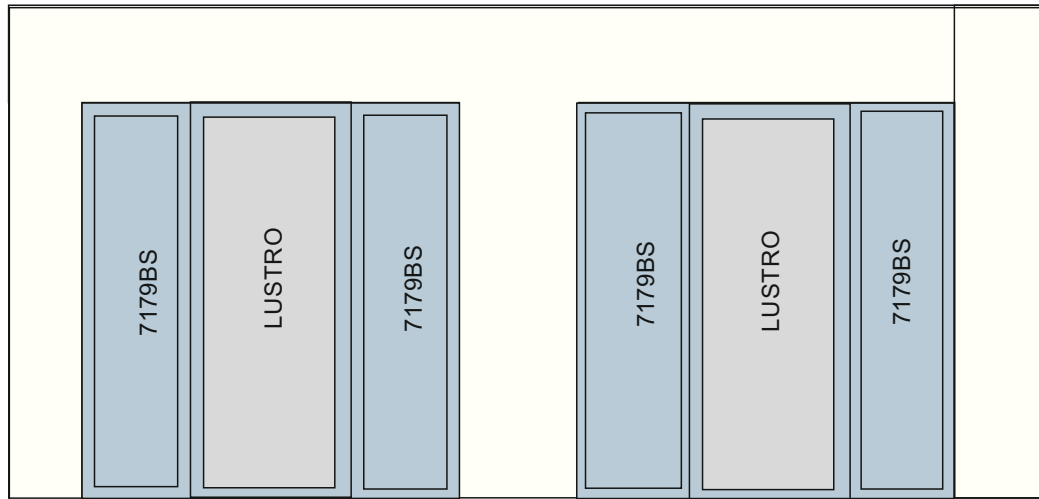

UKŁAD STOŁÓW

STOŁY 160X100

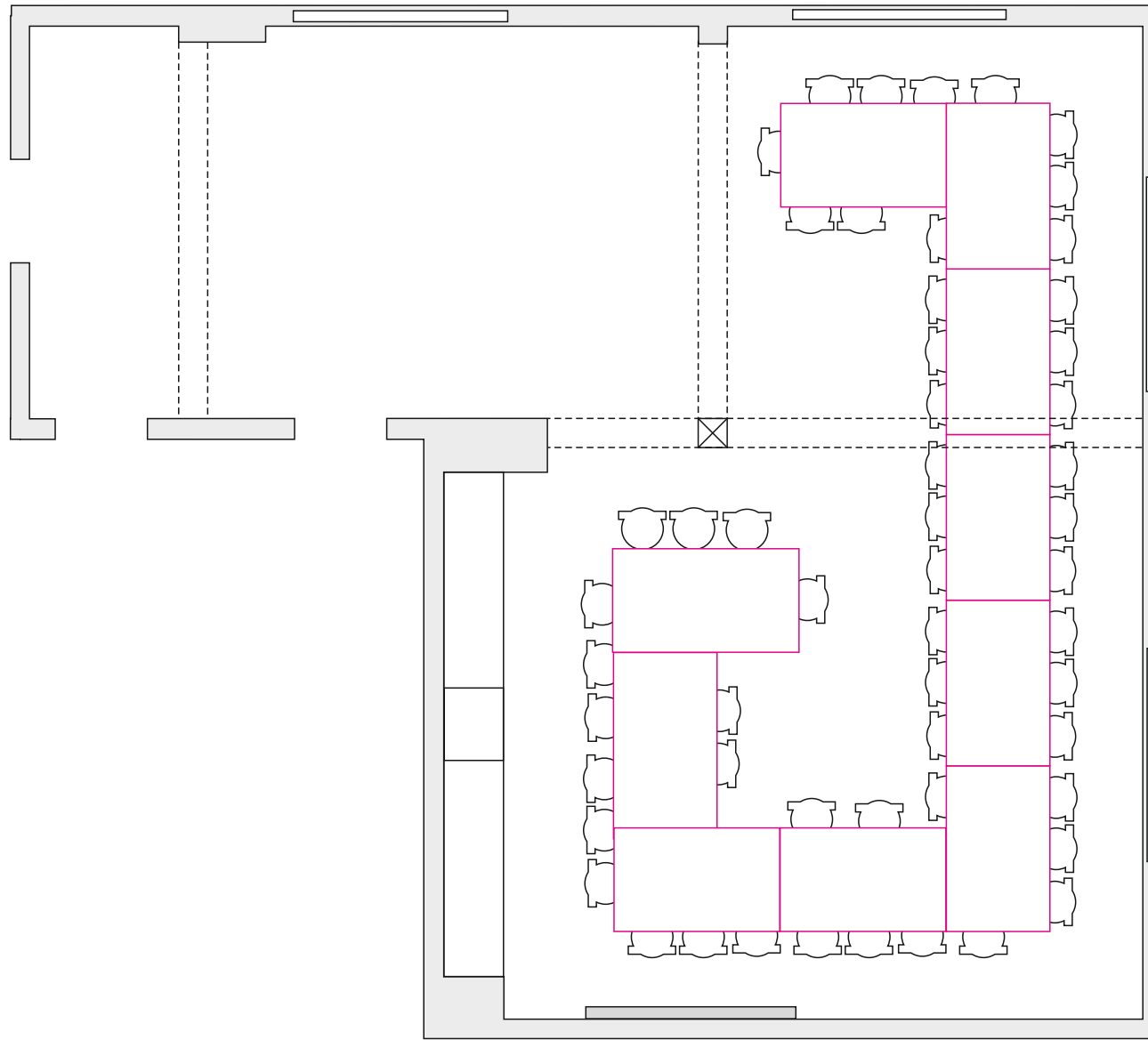

Żyrandol 1399 z serii AXEL - JUPITER 3szt,



Zasilanie:~230V
Materiał:metal,
szkło
Wysokość:65 cm
Szerokość:72 cm
Źródło światła:5 x E27 max 60W

AXEL 1400 AX K B Jupiter 2szt.



Lampa Żyrandol AXEL 1398 Jupiter 1szt.



*Niezbędne zastosowanie kleju C310
do łączeń listew ściennych i gzymsowych.*



LNG-15 19 SZT.

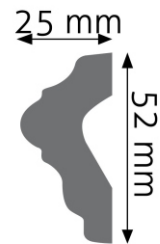

LNG-04 14 SZT.

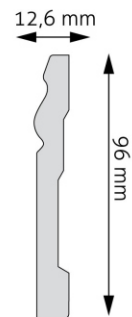

LPC-08 17 SZT.



Klej do łączeń C310 2 SZT.



Klej montażowy C300 15SZT.

SZTUKATERIA

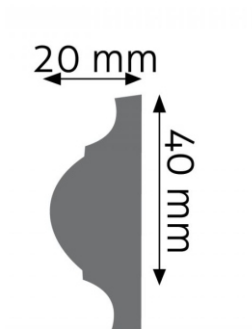

LNG-09 8SZT.

WYPOSAŻENIE

W projekcie ujęto 55 krzeseł i 10 stołów



Krzesło Zina 48x88 cm jasnoszare



Stół 180X100



Krzesło A-225 Fameg

WYPOSAŻENIE



ZS2-150 3szt.
ZS2-200 5szt.
łączniki szyn 8szt.

SYSTEM KARNISZOWY ZS2 CREATIVA

