

KM. 0+000.00

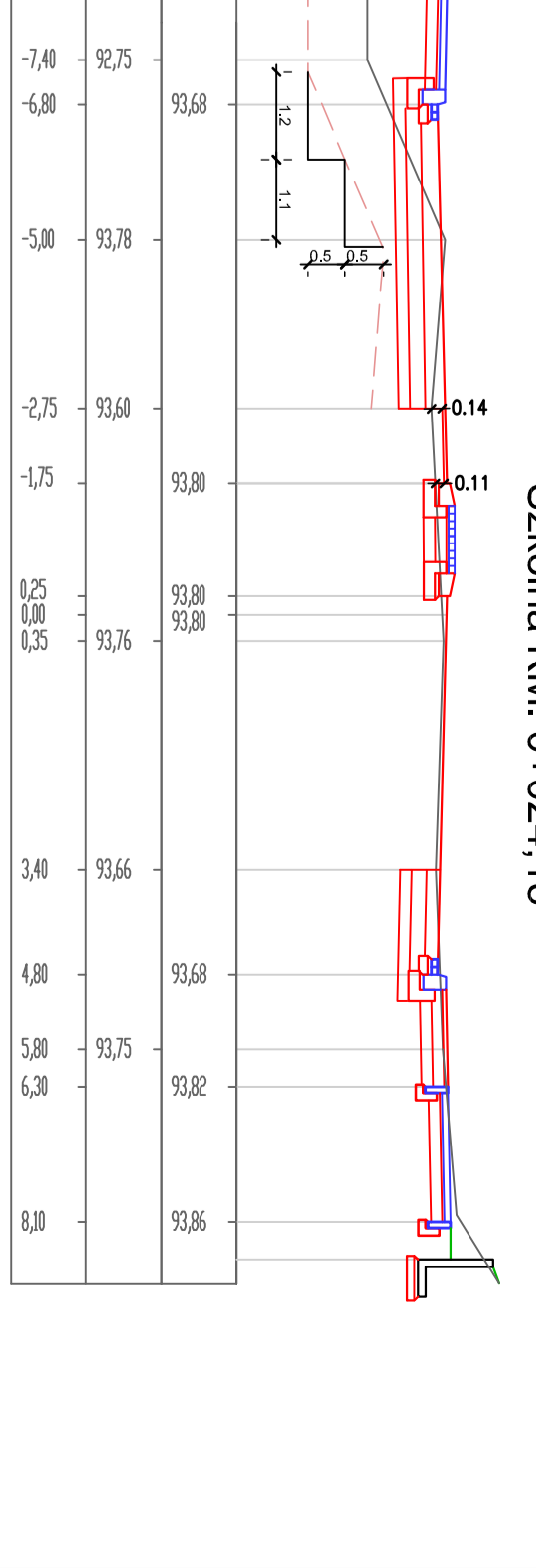

KM. 0+062.00

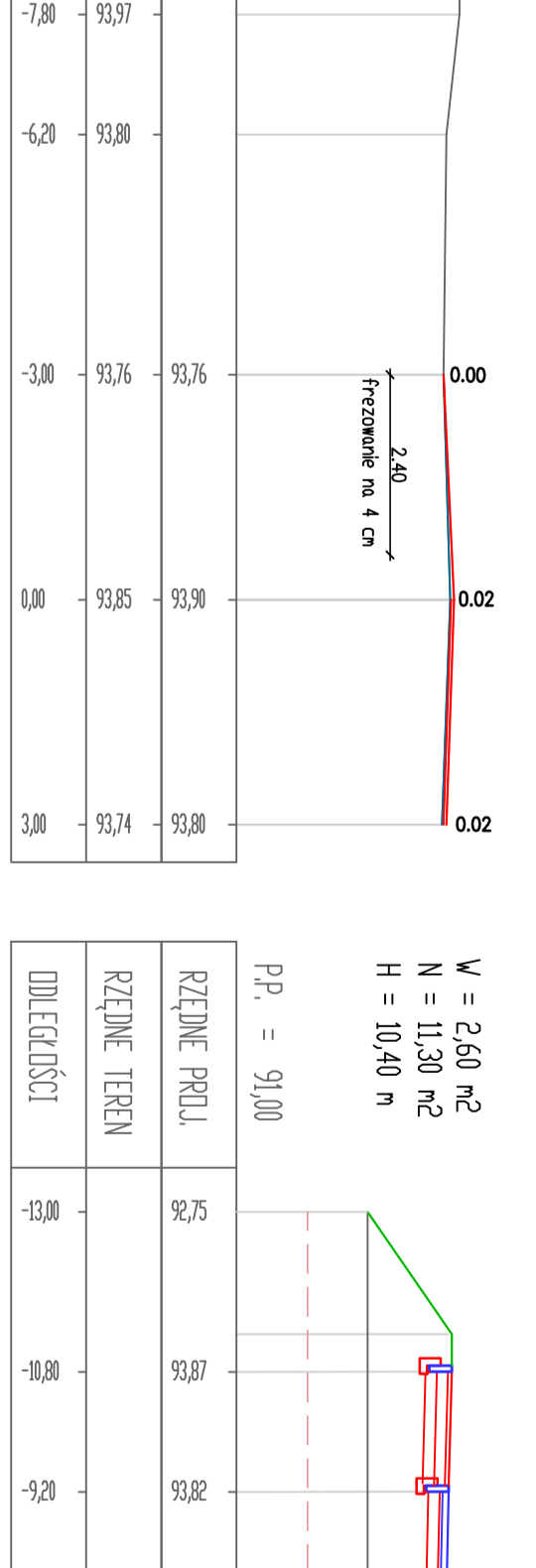
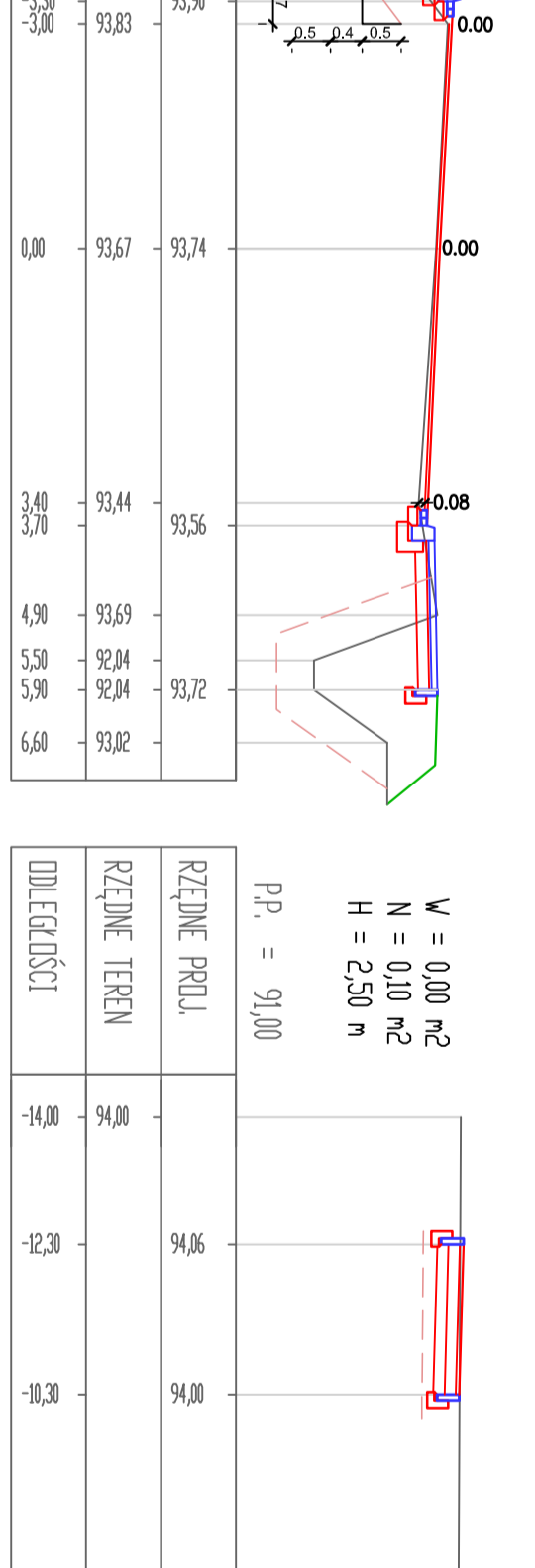
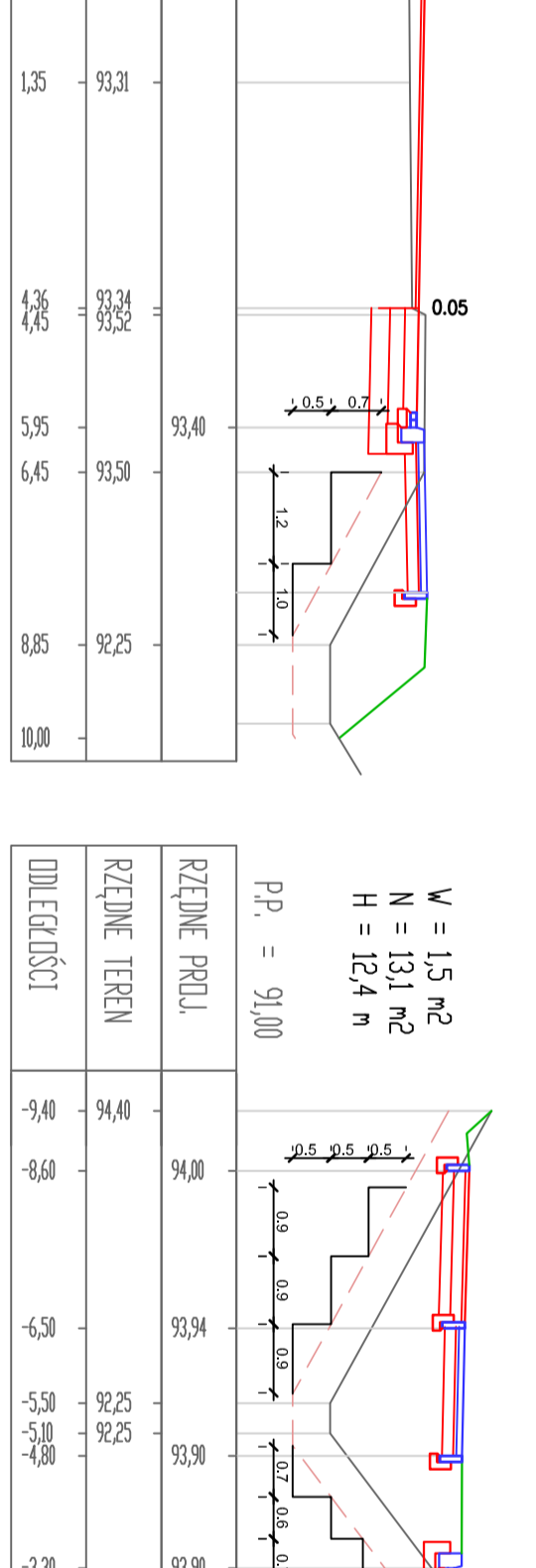
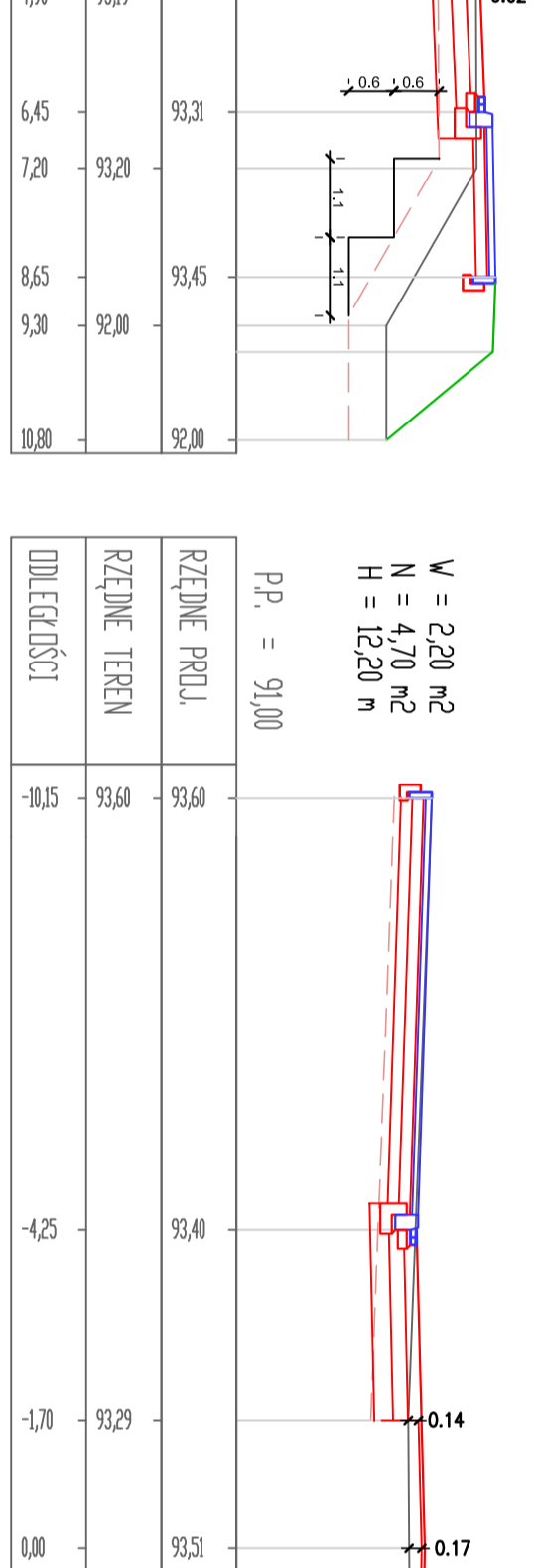
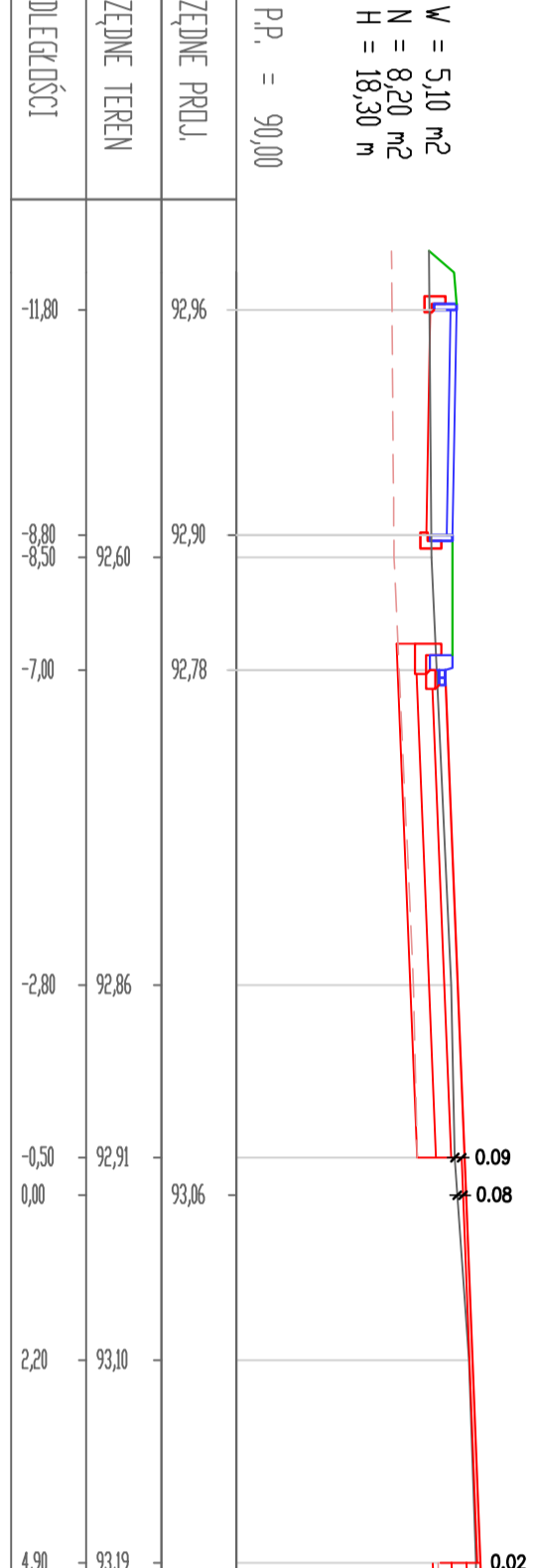
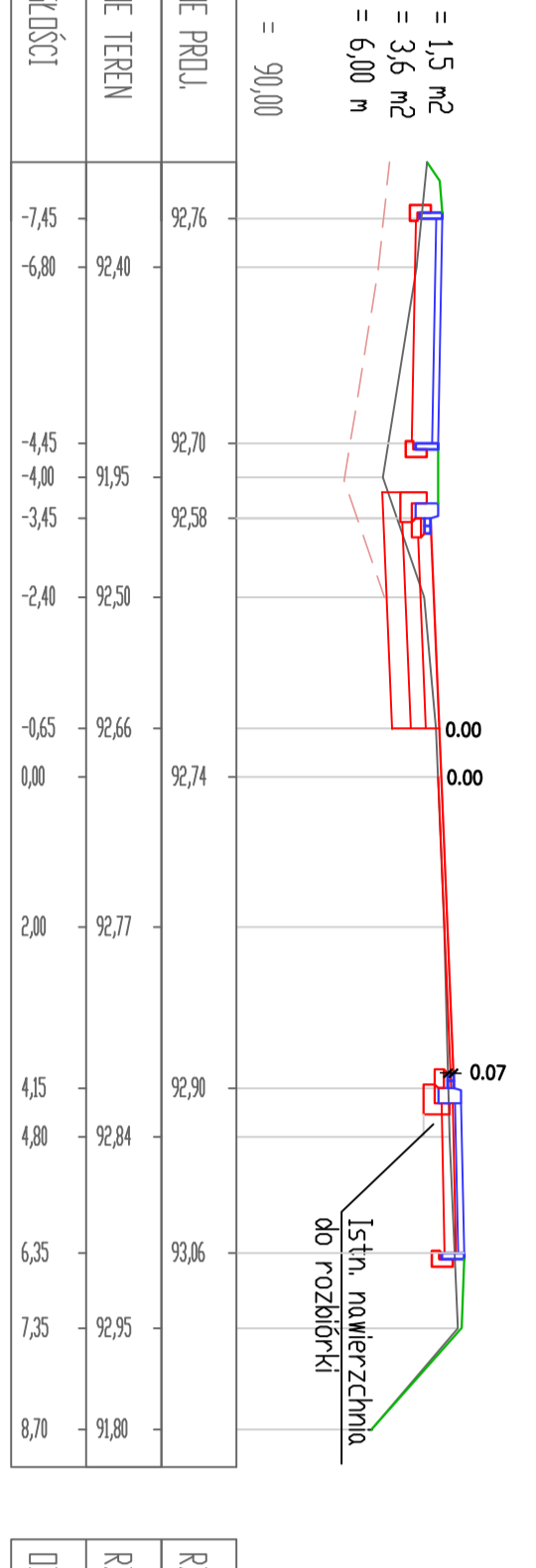
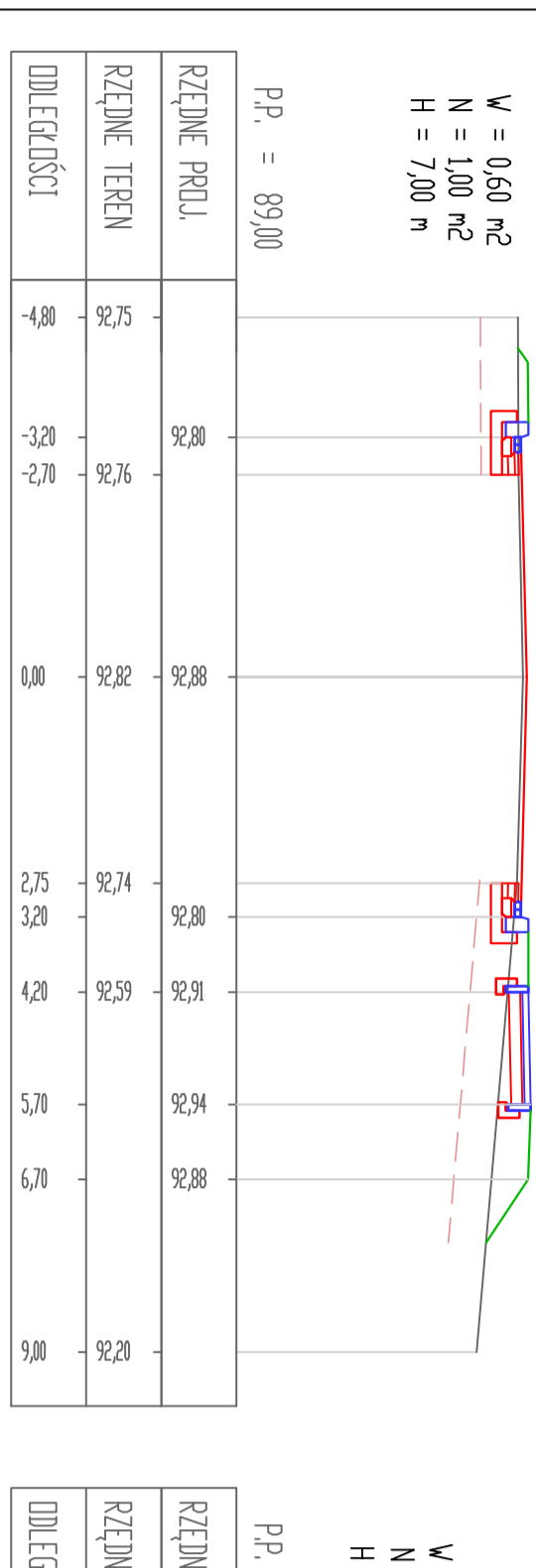
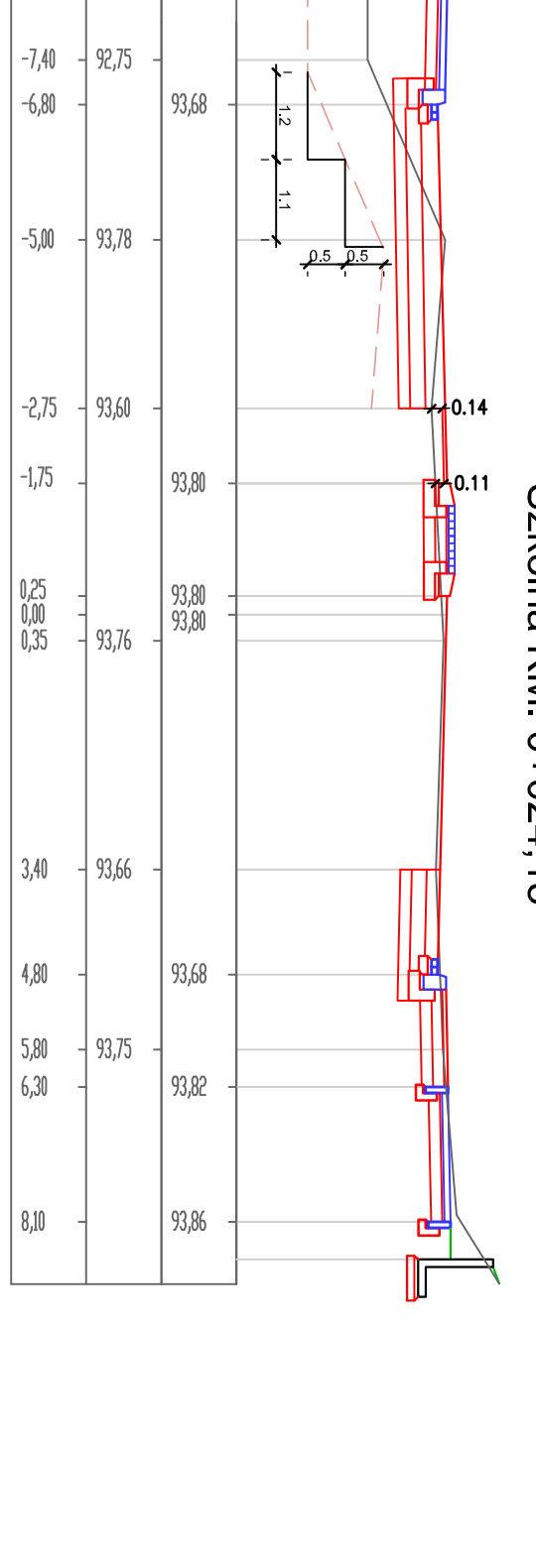
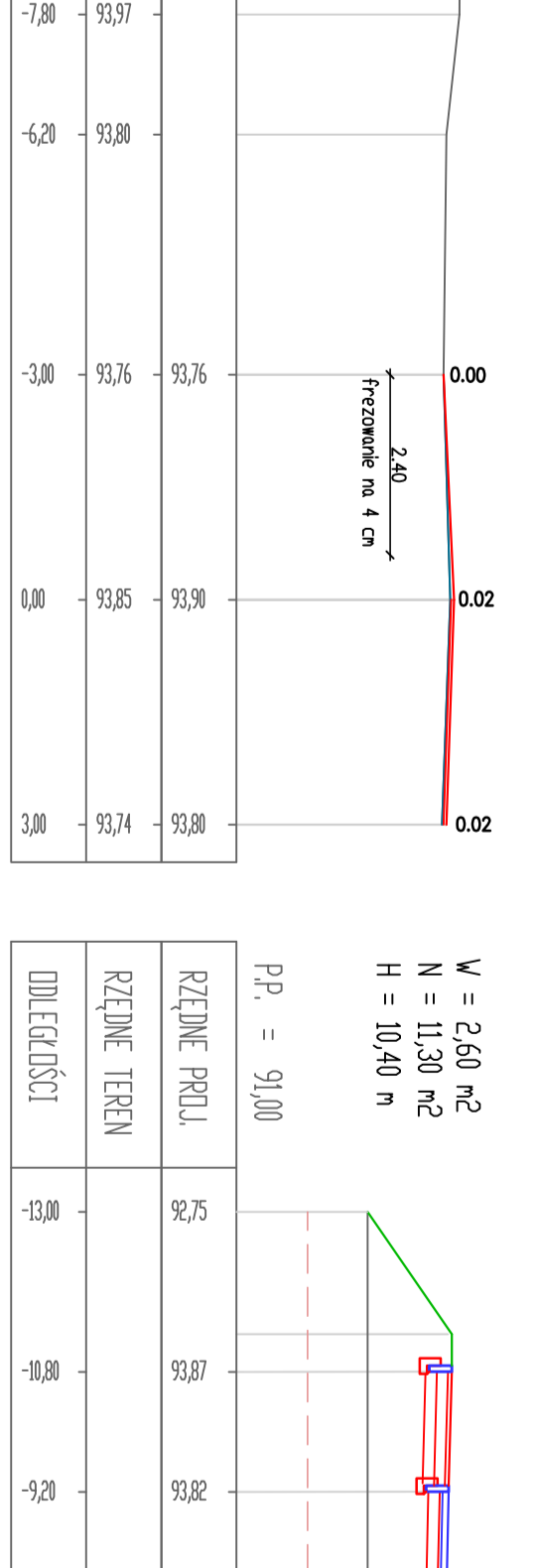
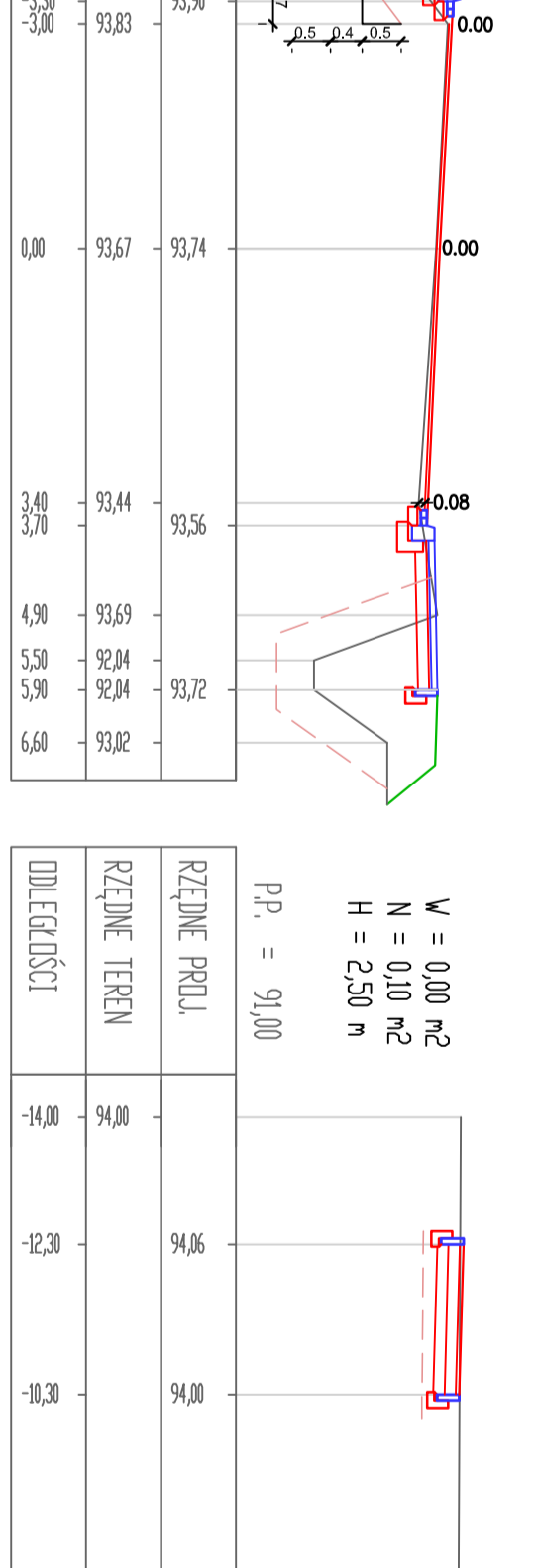
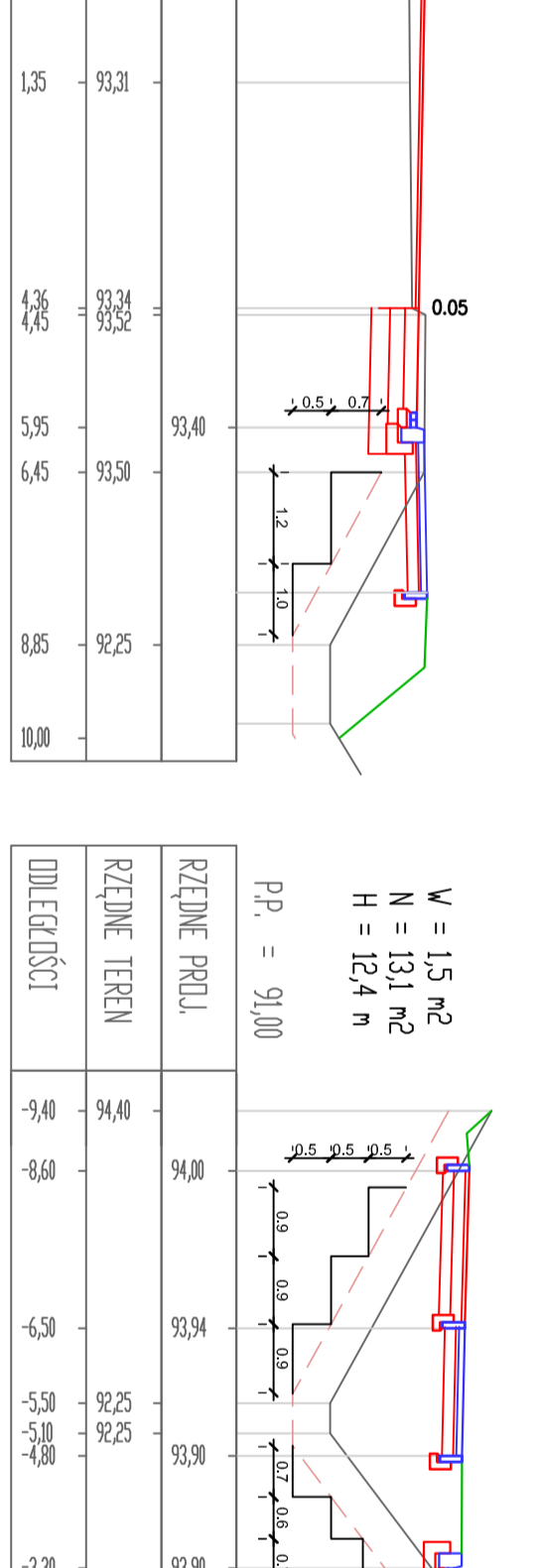
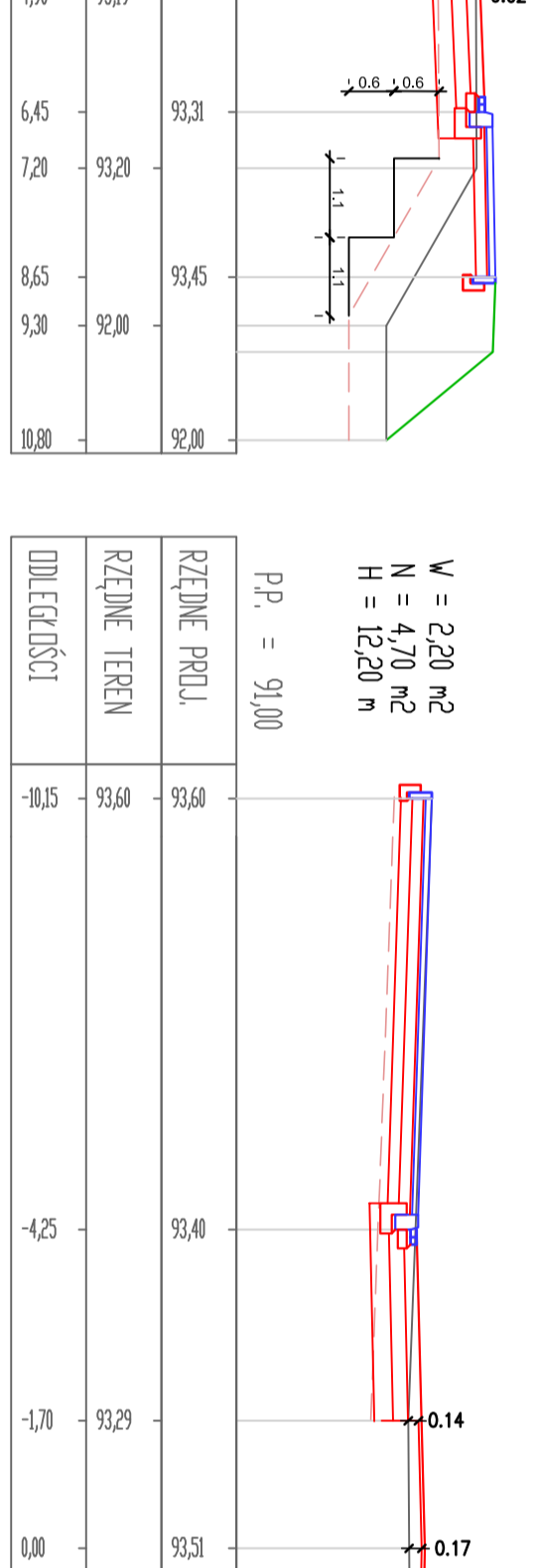
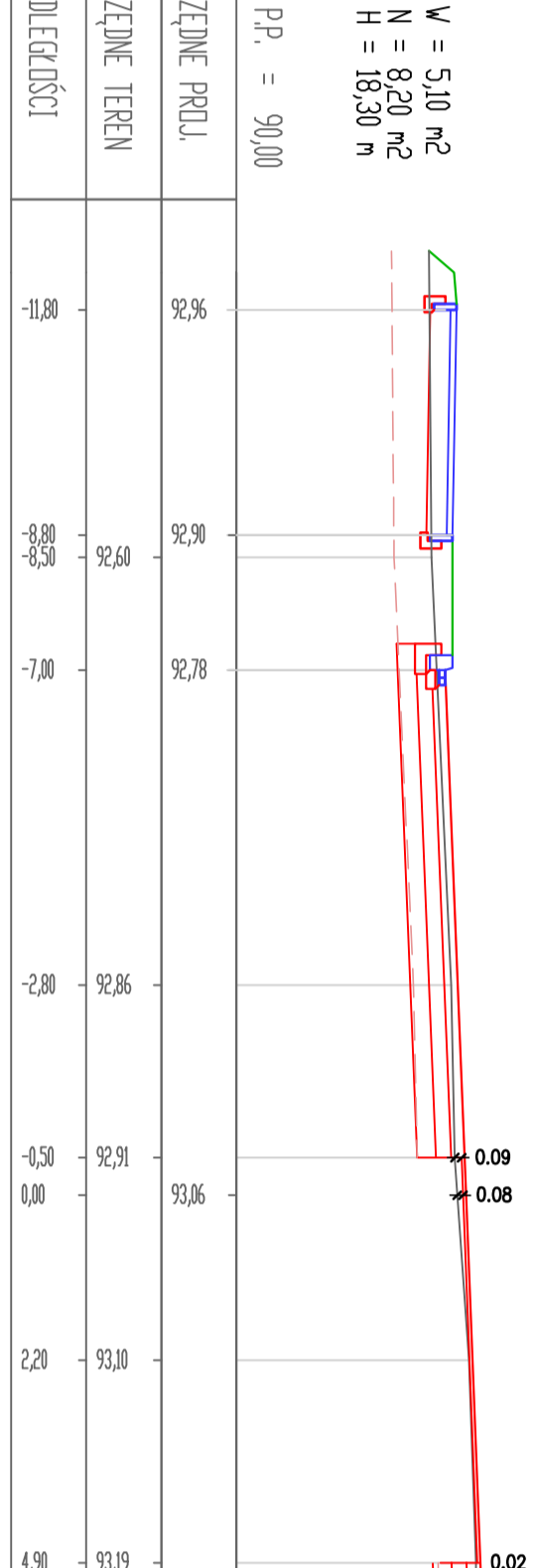
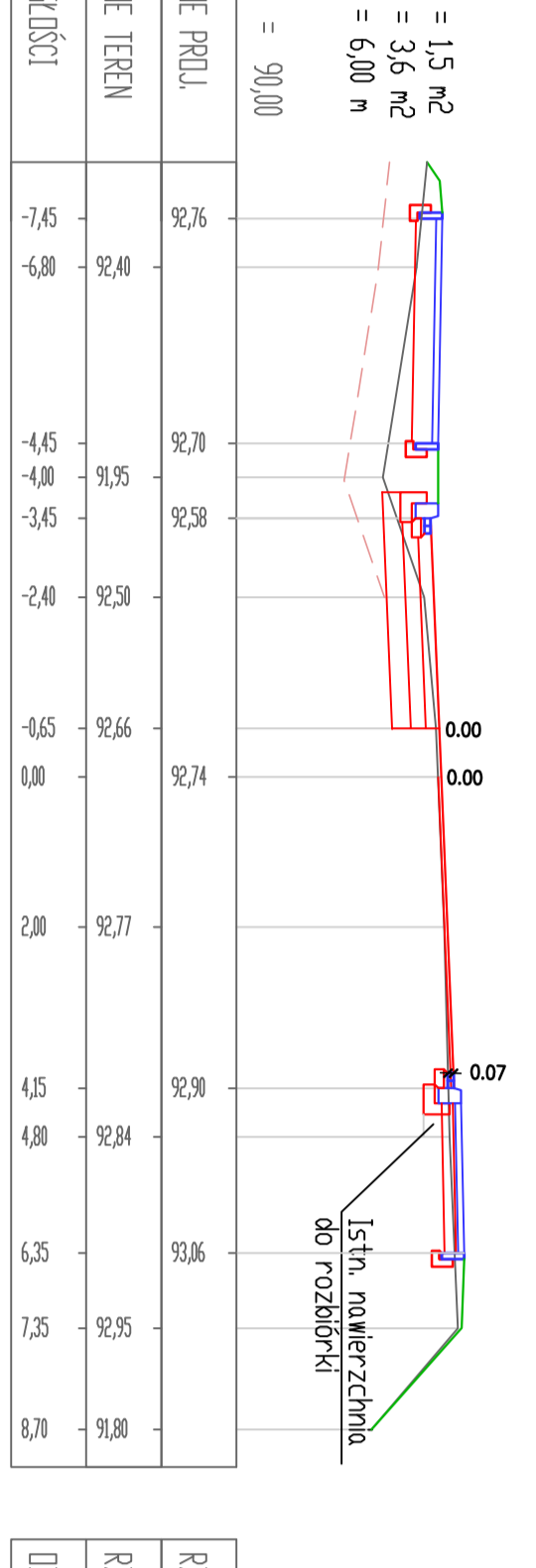

KM. 0+127.85

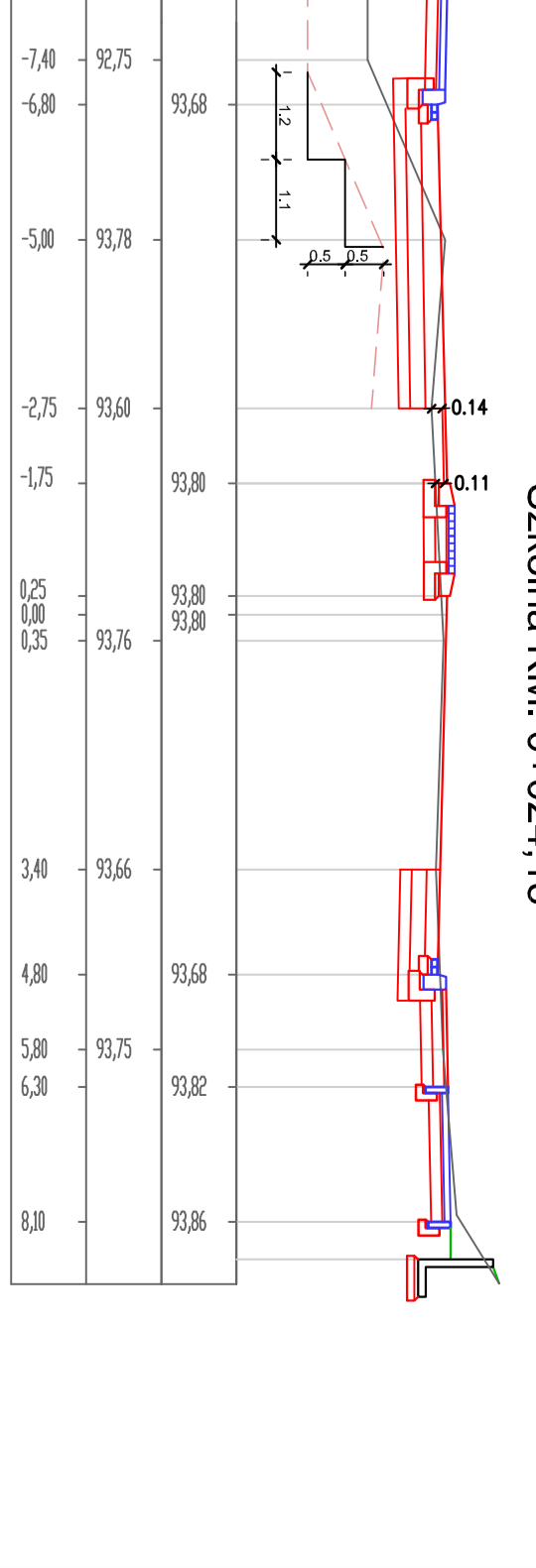
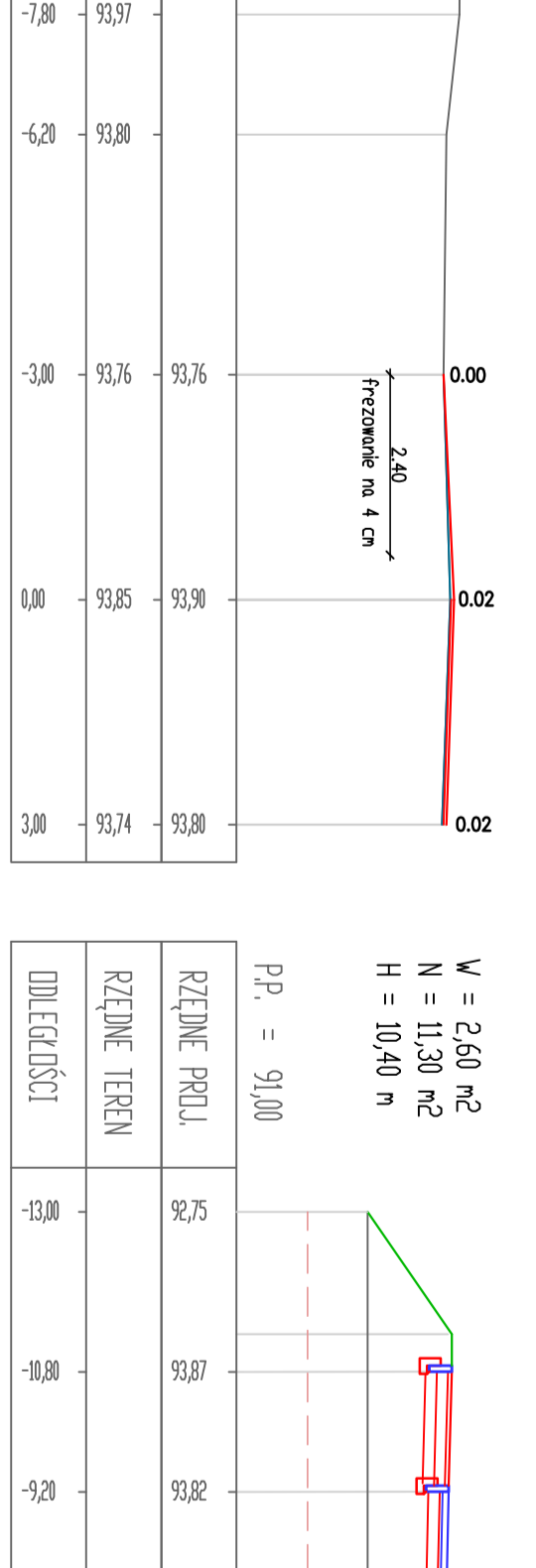
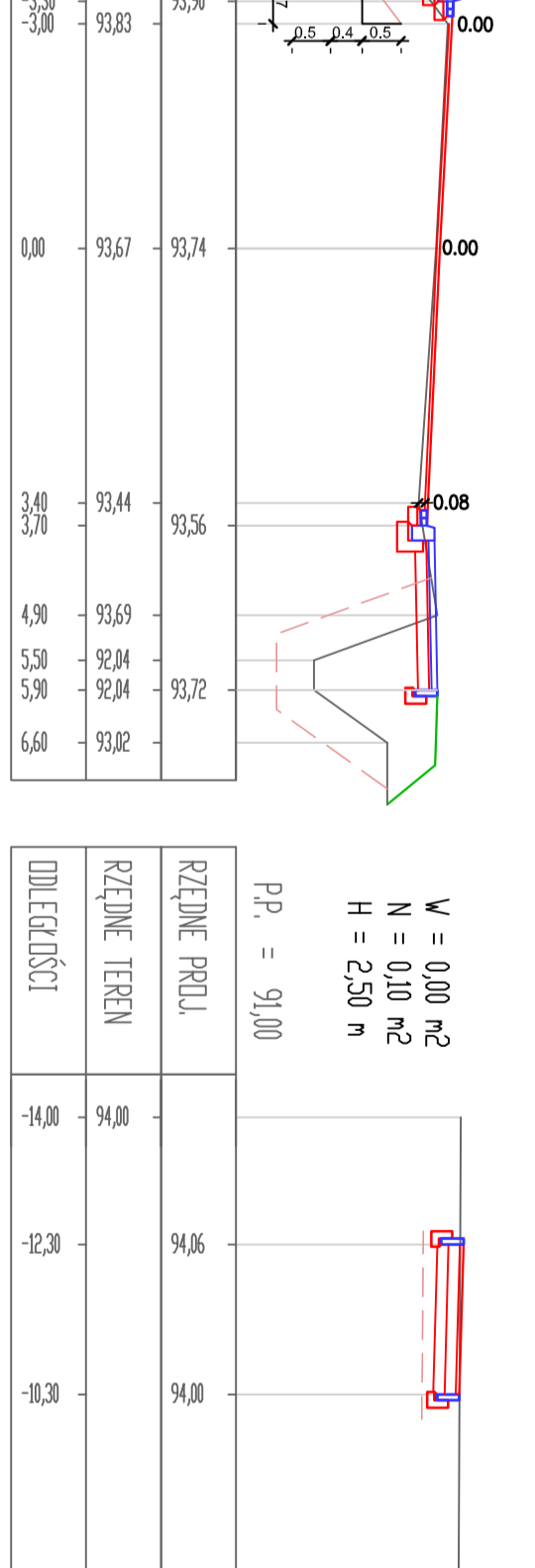
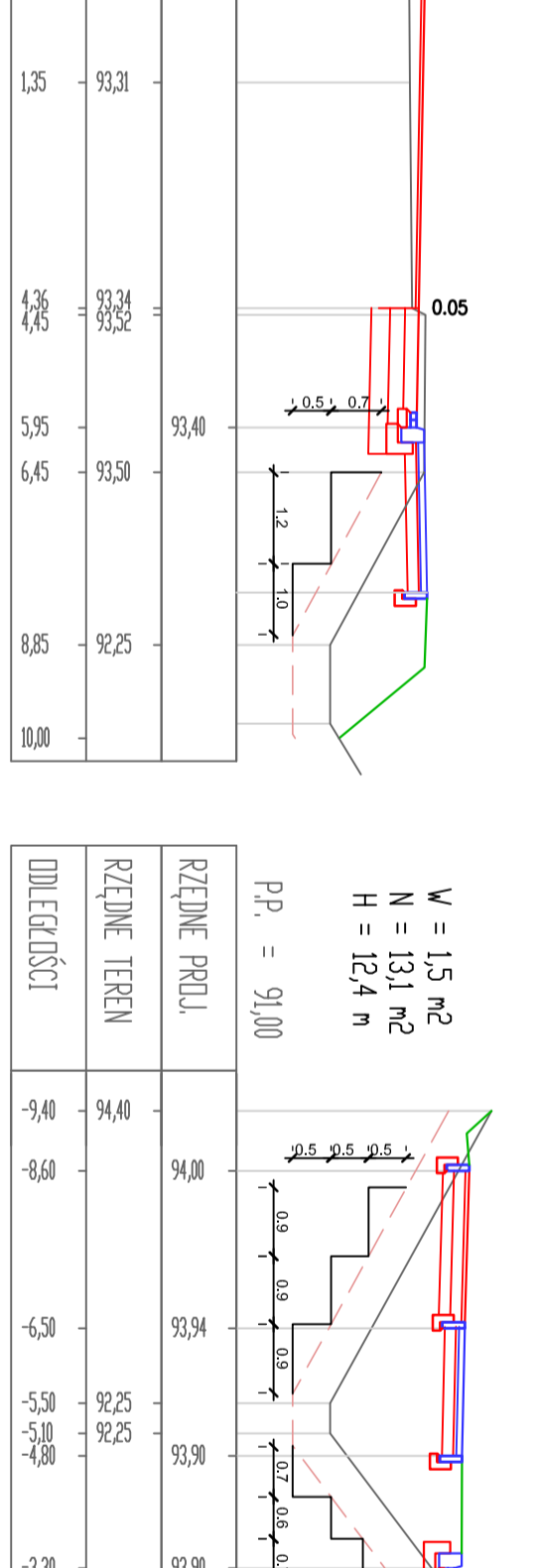
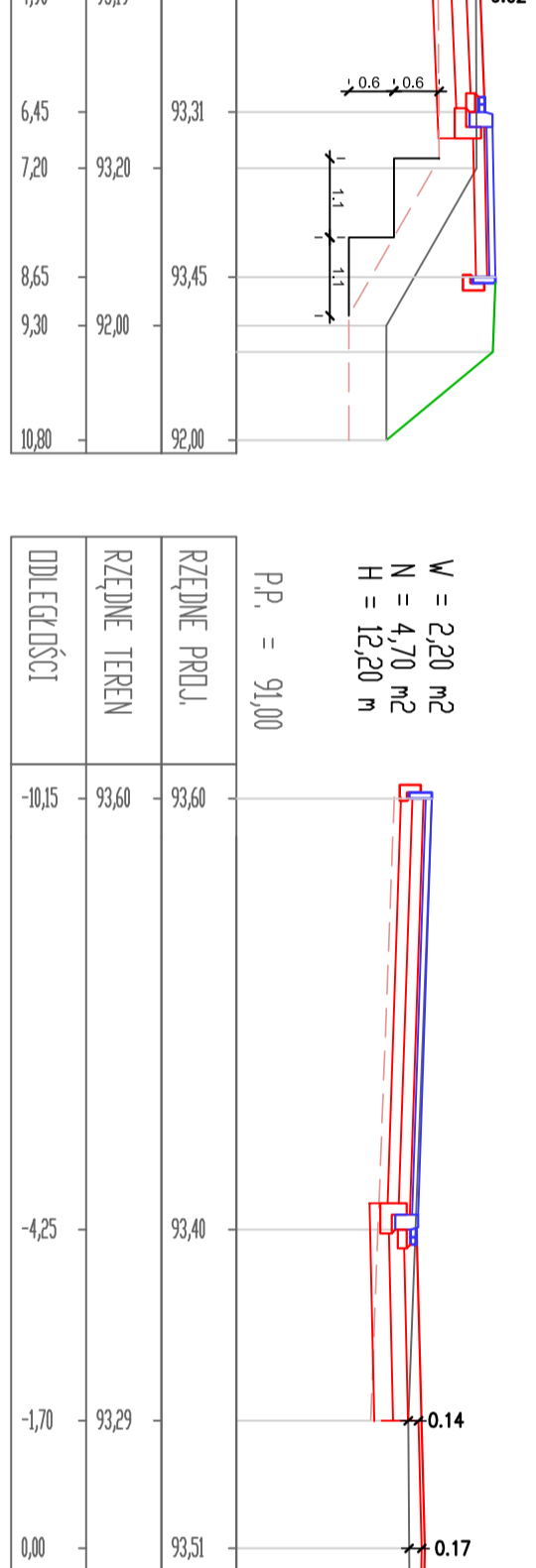

KM. 0+172.50

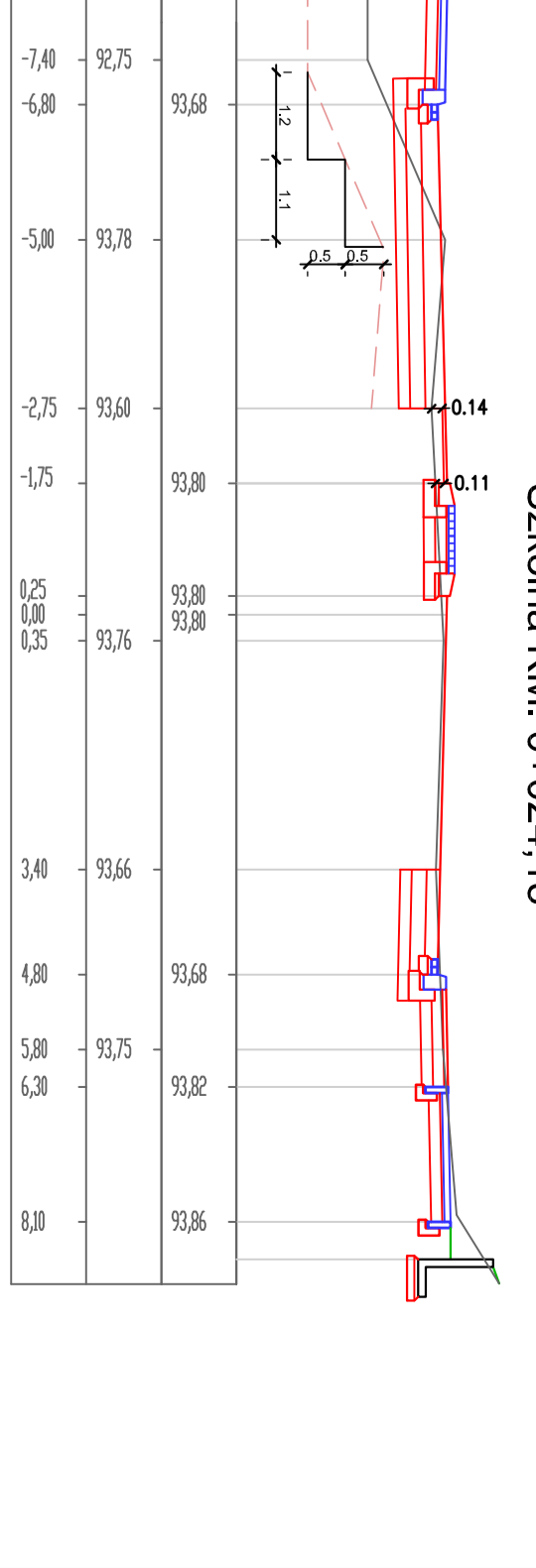
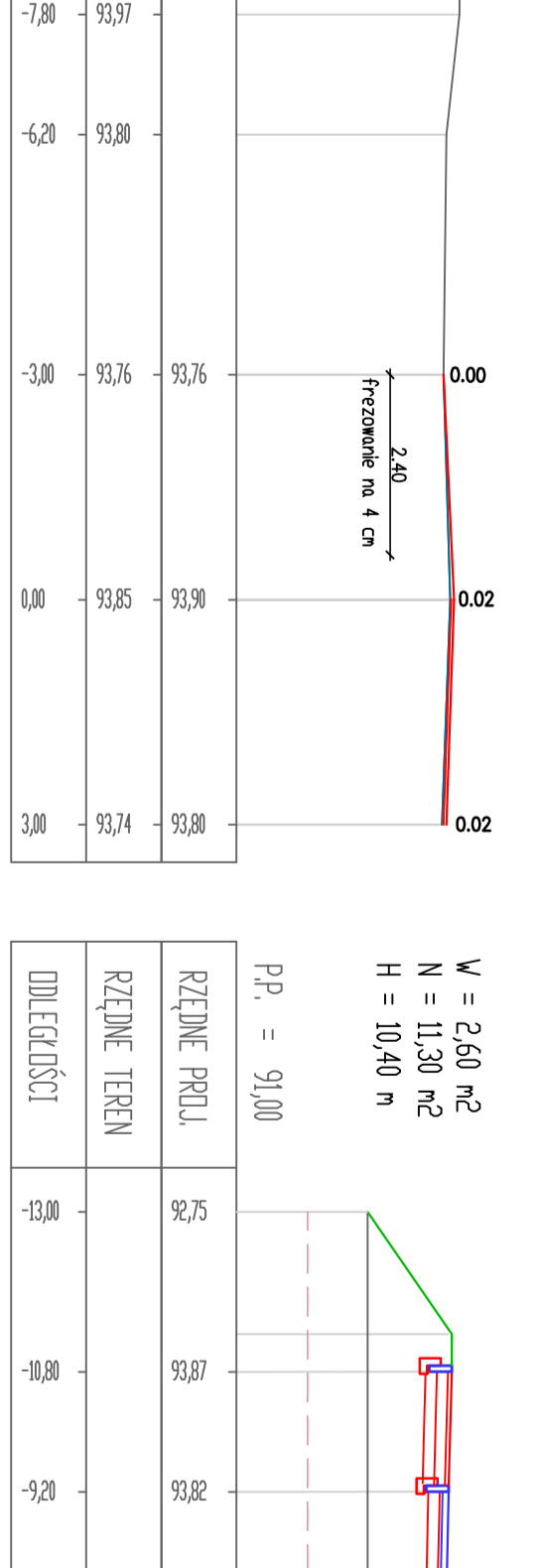
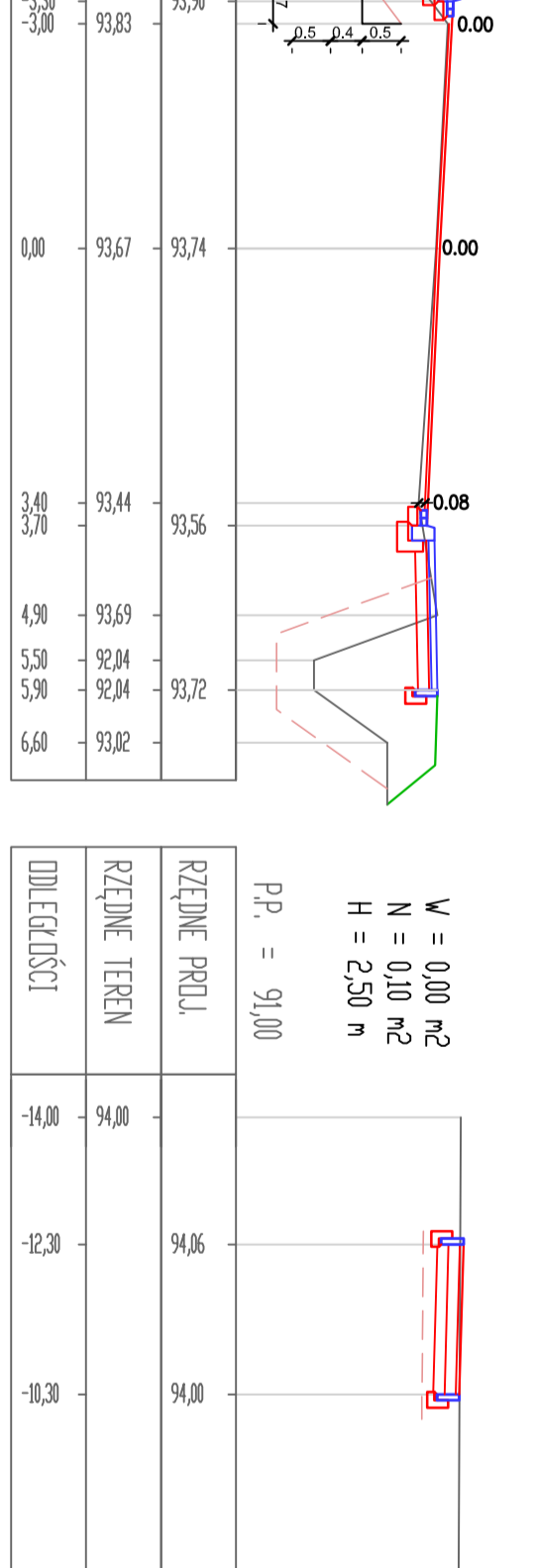
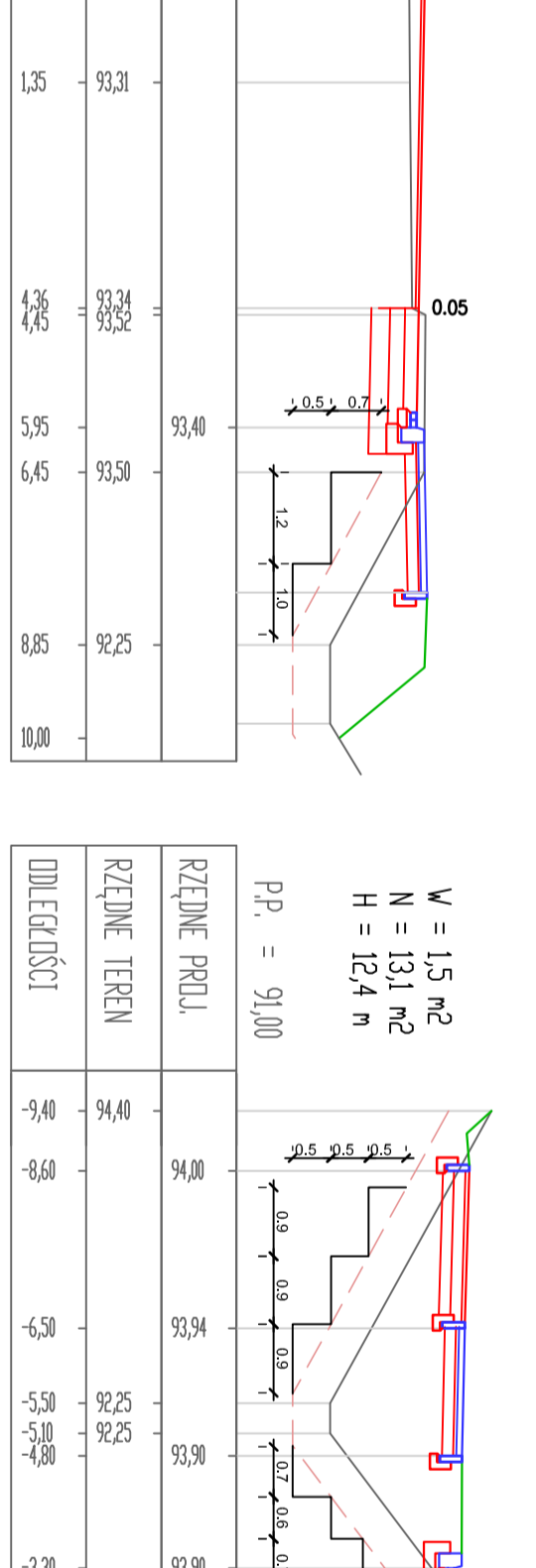

KM. 0+218.30

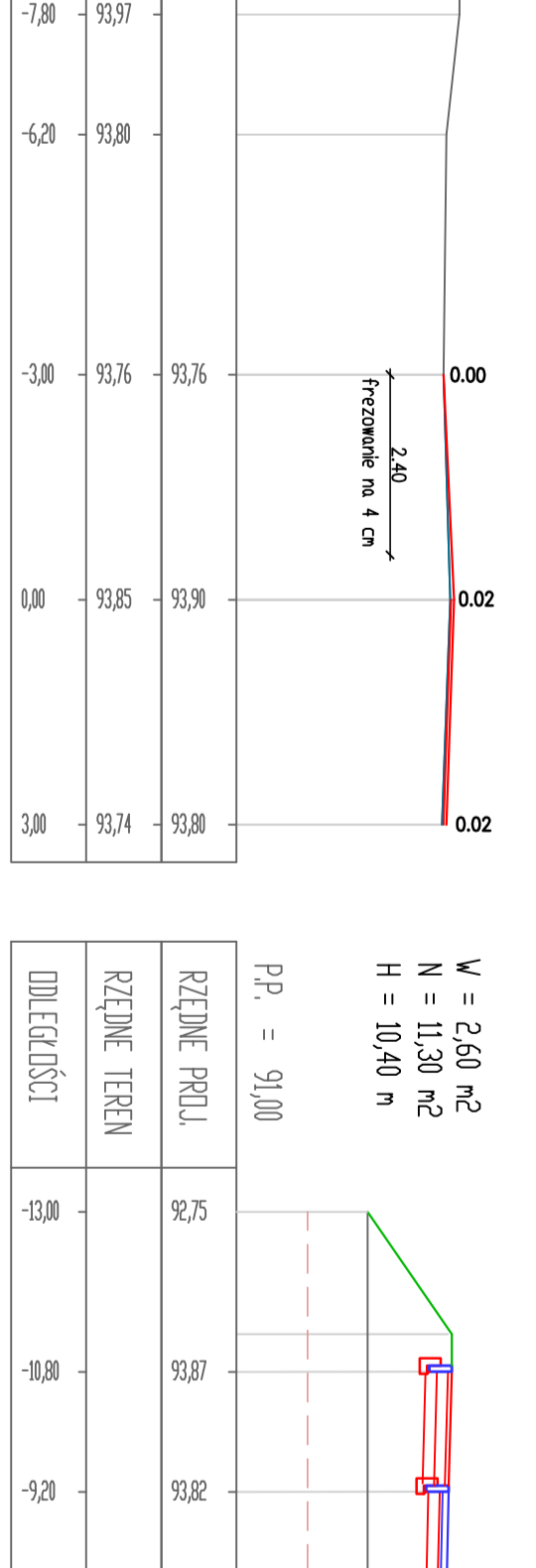
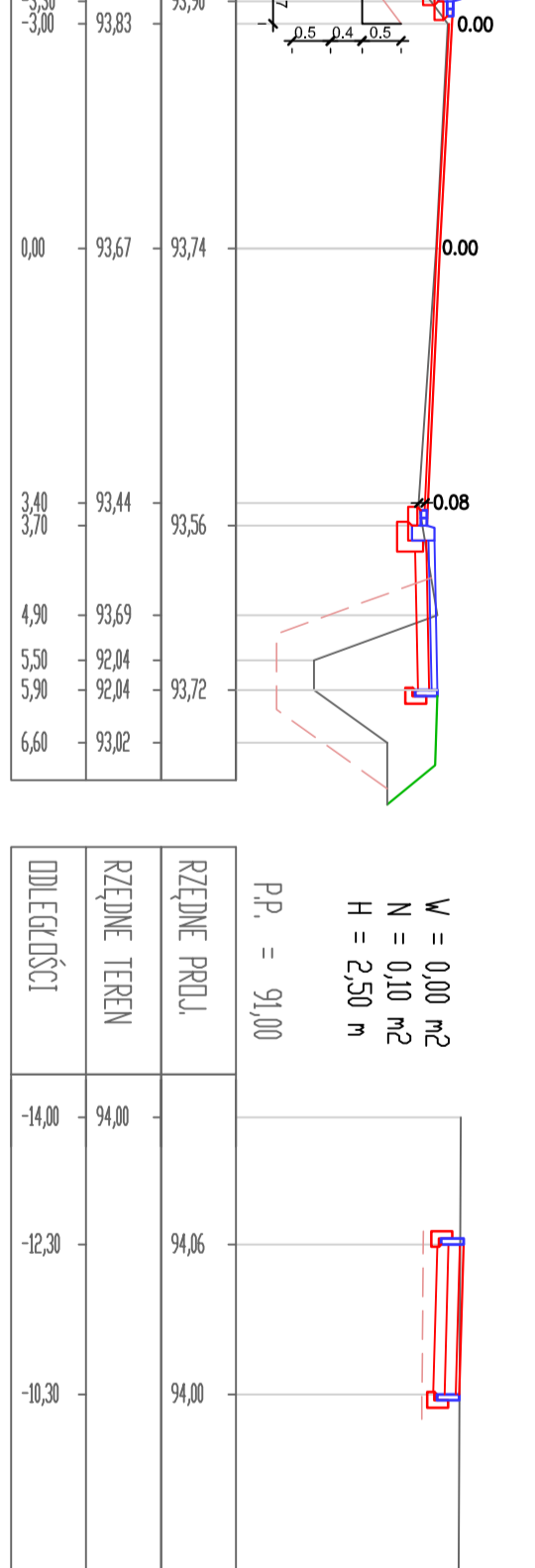

KM. 0+258.50

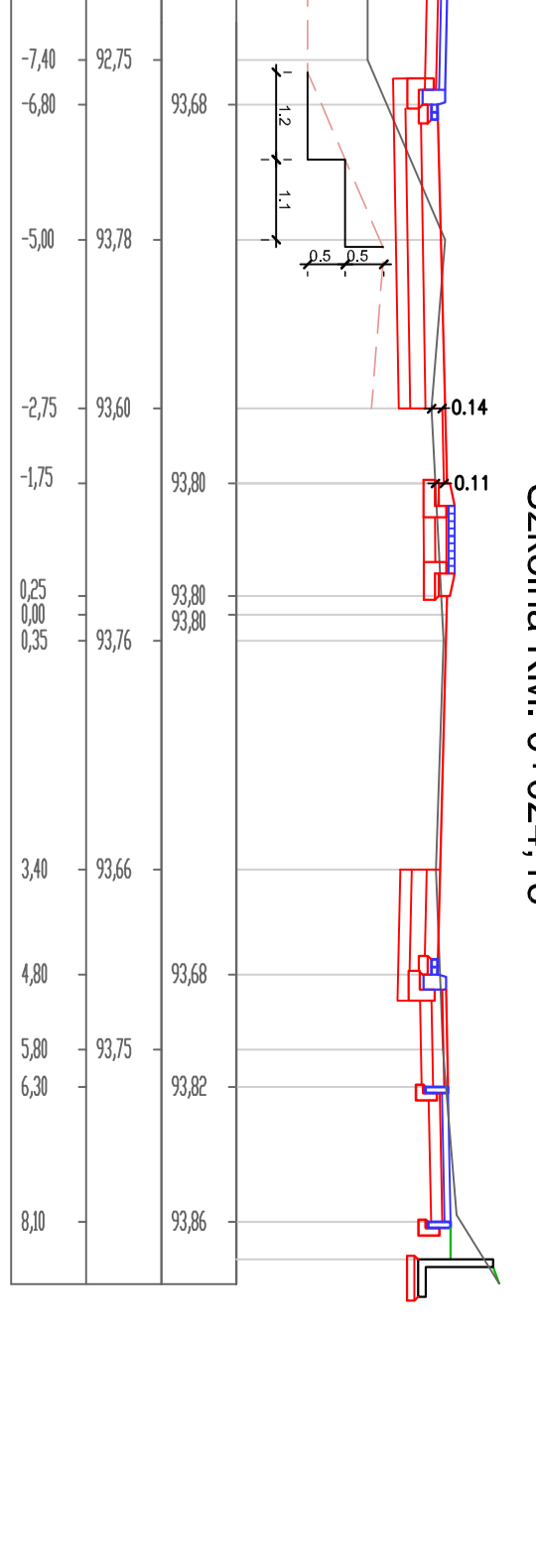
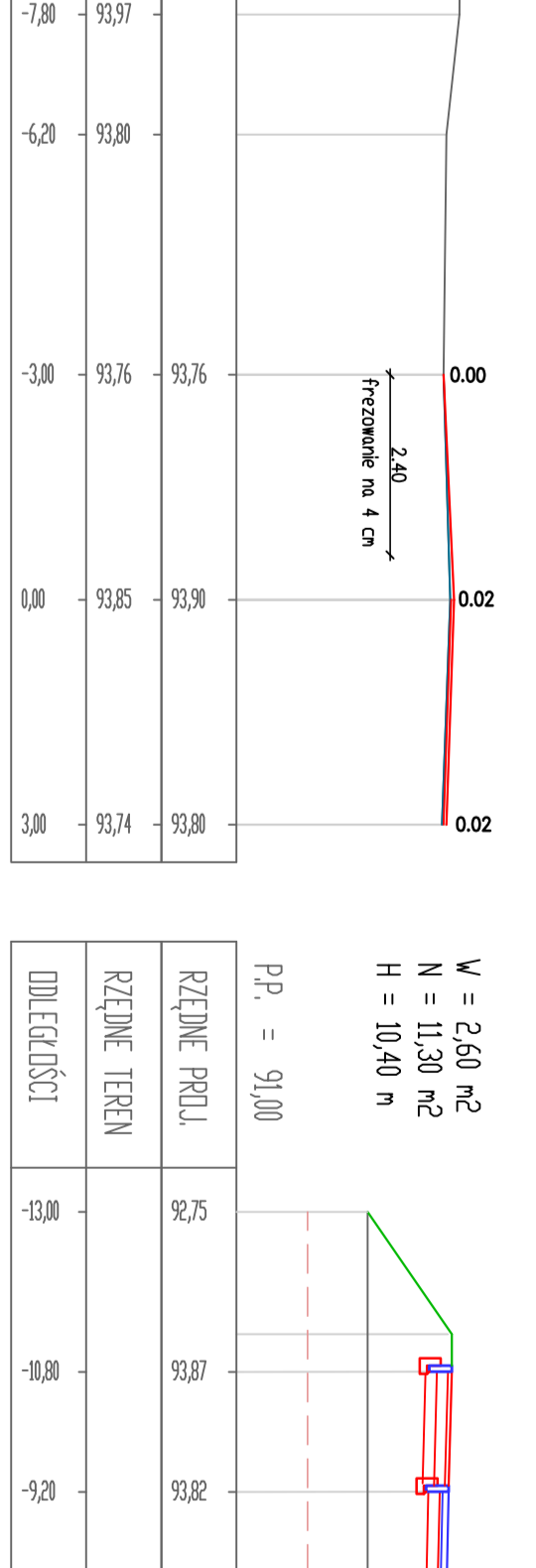

Skolna KM. 0+024.15

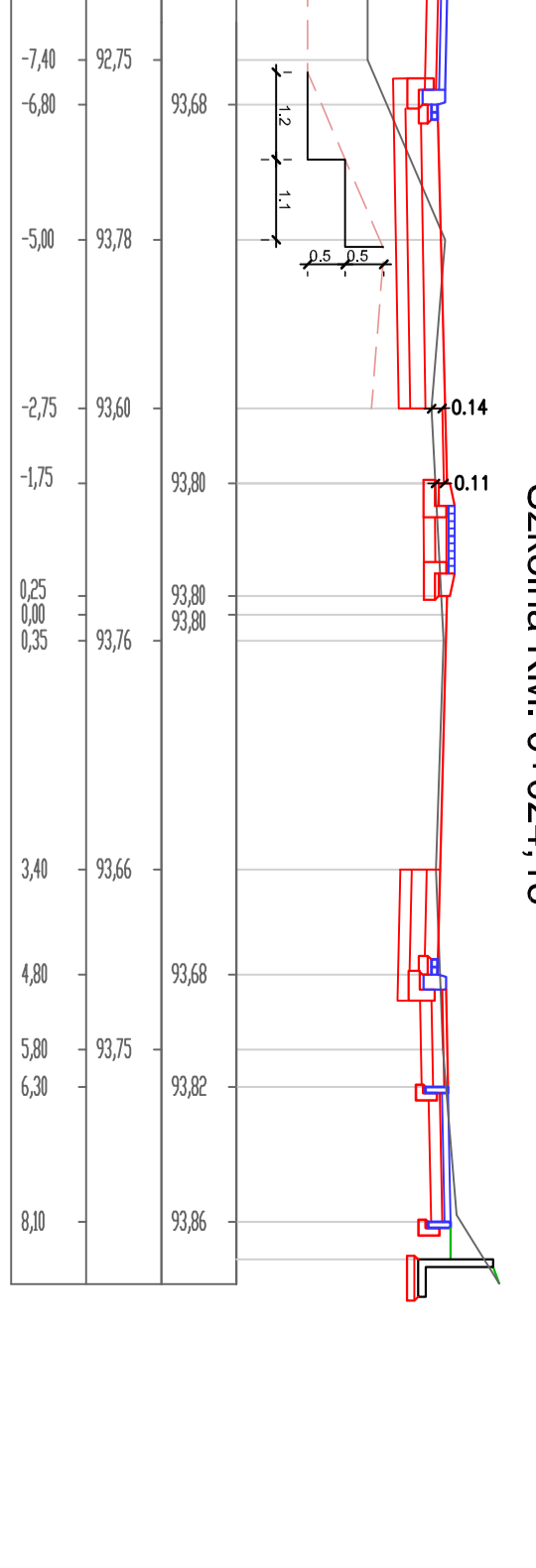

Skolna KM. 0+058.34

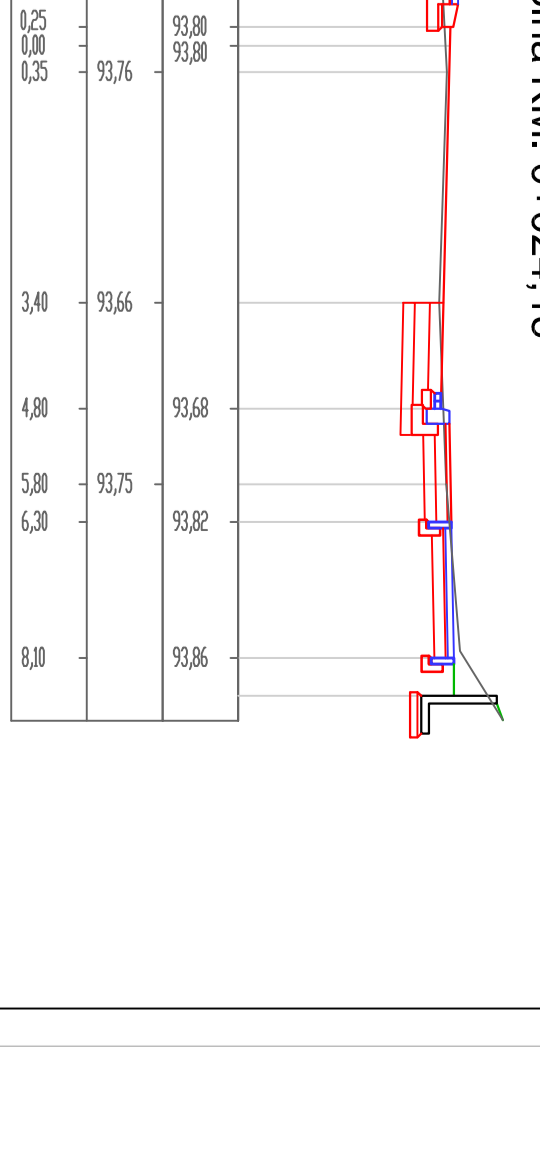

- Nawierzchnia bitumiczna
- Nawierzchnia kostki brukowej
- Trawa
- Zdielcie humusu

Wykonawca:	WOJCIECH ZOLEK oś. Lesłna 18b/63, 62-2028 Koziegłowy
Investor:	ZARZĄD DRÓG POWIATOWYCH W POZNAŃU ul. Zielona 8, 61-851 Poznań
Data:	10.2022

PRZEBUDOWA/ROZBUDOWA DROGI 2407P KOZIEGŁOWY -
SWARZĘDZ W OBRĘBIE SKRZYŻOWANIA UL. POZNAŃSKIEJ
Z UL. SZKOLNĄ W KICHMIE
PROJEKT TECHNICZNY

Skonowator:	Ing. inż. W. Zolek	Wzrost: 173 cm	Podpis:
Projektant:	mgr inż. G. Nowacki	Wzrost: 182 cm	Podpis:
Skonowator:	mgr inż. G. Nowacki	Wzrost: 182 cm	Podpis:
Projektant:	mgr inż. G. Nowacki	Wzrost: 182 cm	Podpis:

PRZEKROJE POPRZECZNE
Skala: 1:100
Nr rys.: 5