

# Biurko 1

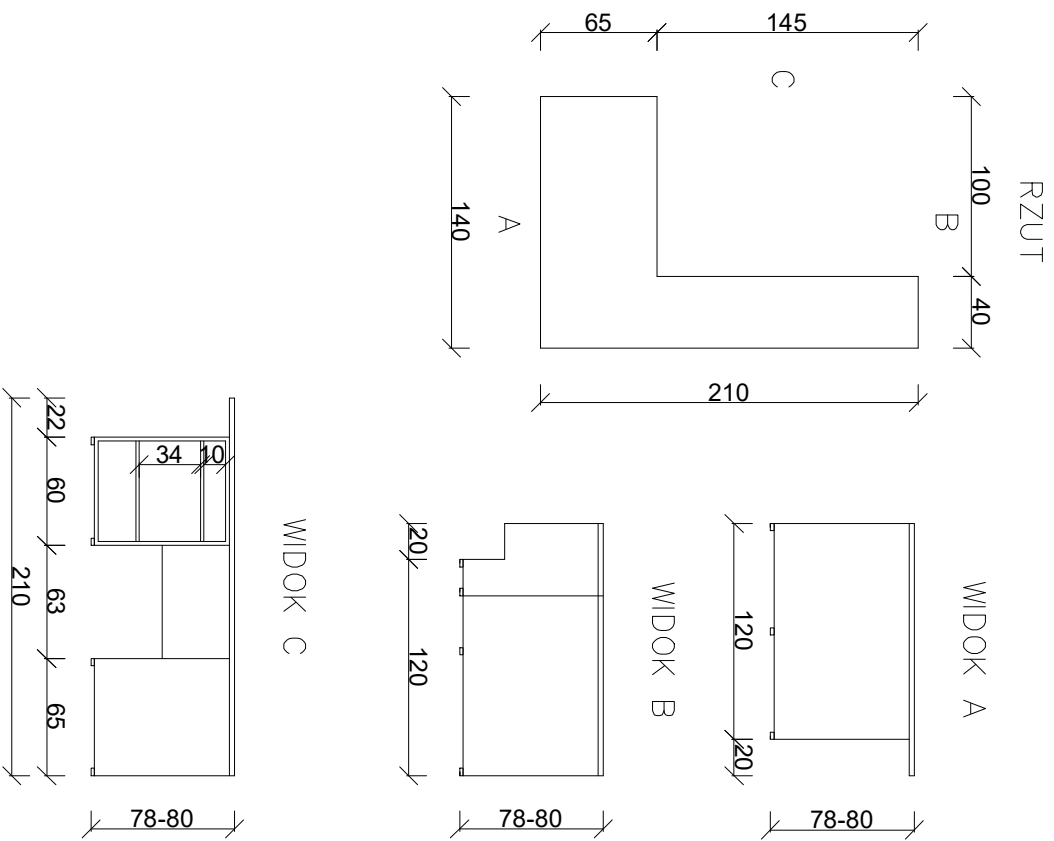

Uwaga:  
Widoczne wcięcia na widoku B i C konieczne są ze względu na występowanie zabudowy przypadkowej o wymiarach ok. 20x20cm.

# Szafka 1

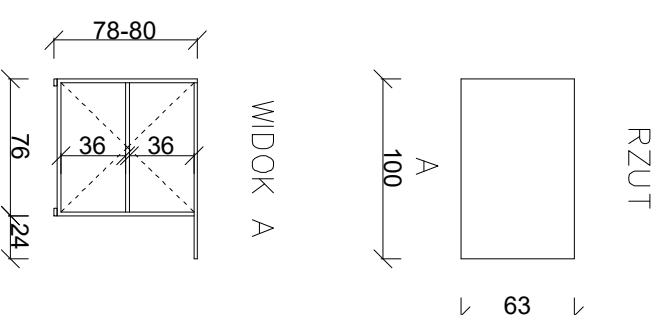

Uwaga:  
W celu dokonania dokładnych pomiarów niezbędna jest wizja lokalna!

# Szafa 1

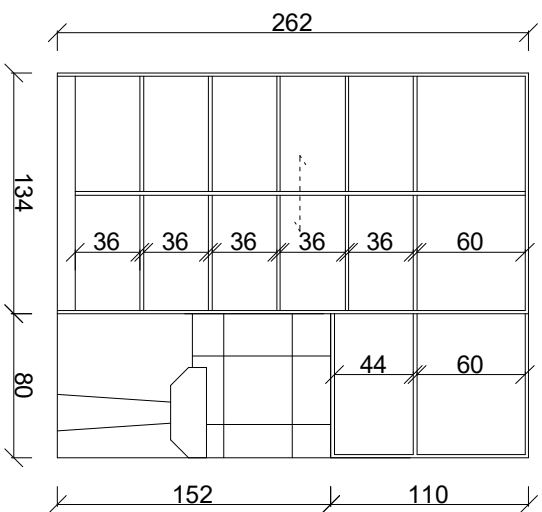
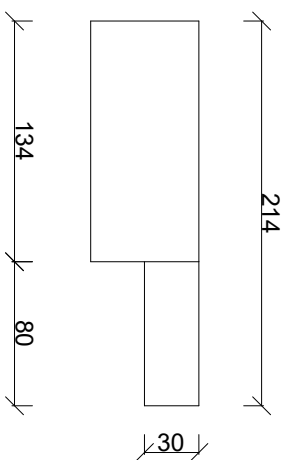

Uwaga:  
Zabudowa szafy od podłogi do sufitu

# Półka 1

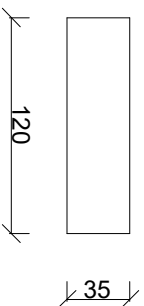

# Biurko 2

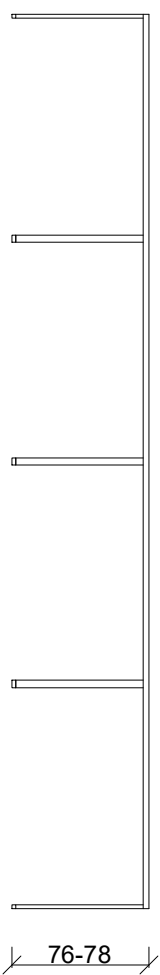
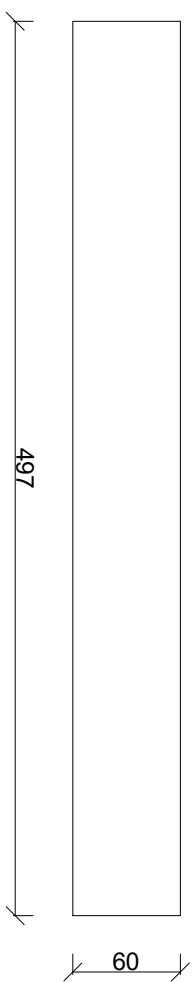

Załącznik nr 5.2

# Biurko 3

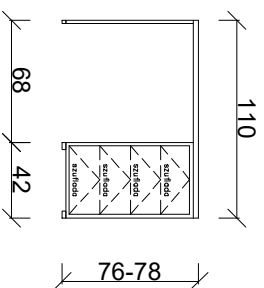
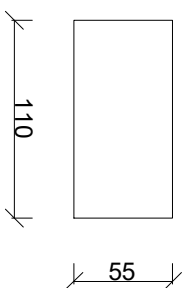

# Kontener 1

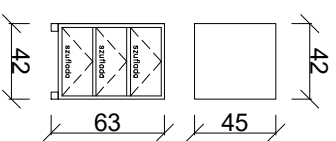

Uwaga:  
W celu dokonania dokładnych pomiarów  
niezbędna jest wizja lokalna!

# Szafa 2

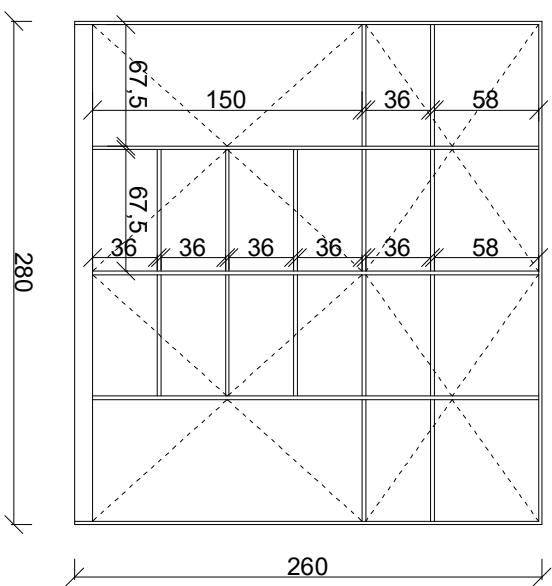
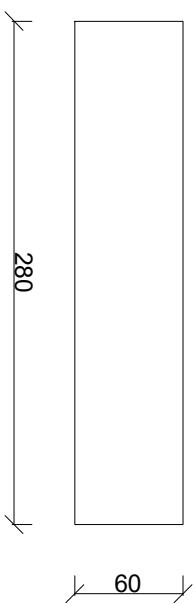

# Półka 2

Załącznik nr 5.3

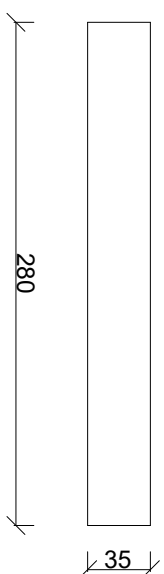

# Półka 3

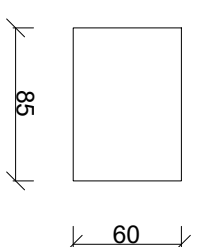

Uwaga:  
W celu dokonania dokładnych pomiarów  
niezbędna jest wizja lokalna!

# Szafa 3

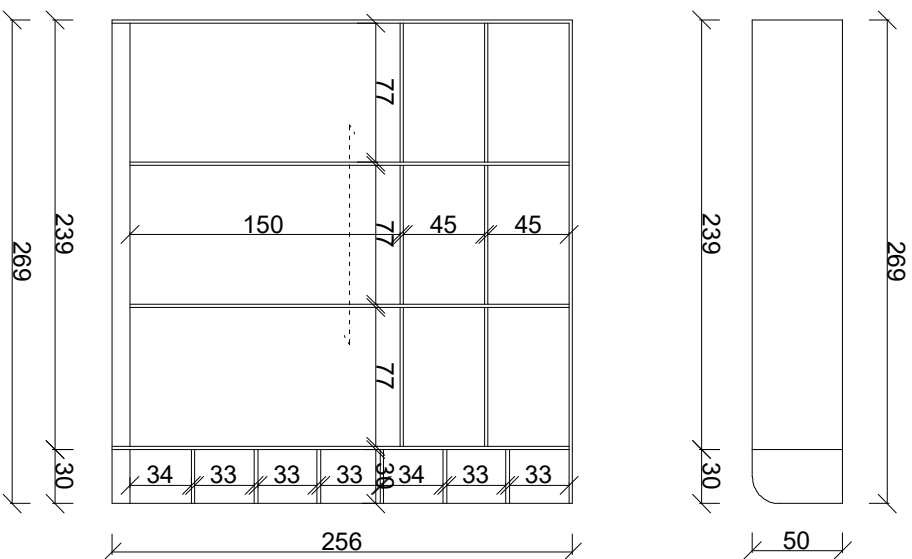

Uwaga:  
Zabudowa szafy od podłogi do sufitu

# Szafa 4

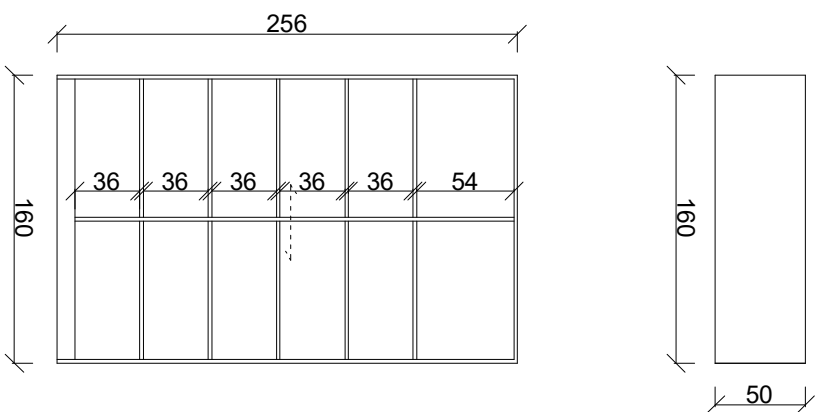

Uwaga:  
Zabudowa szafy od podłogi do sufitu

# Biurko 4

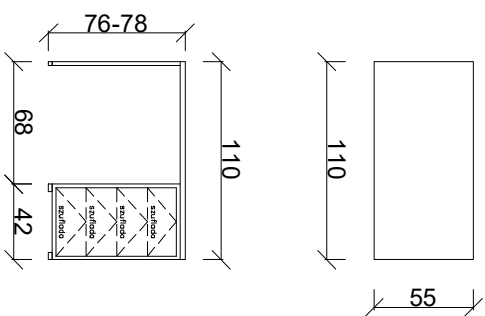

# Wieszak 1

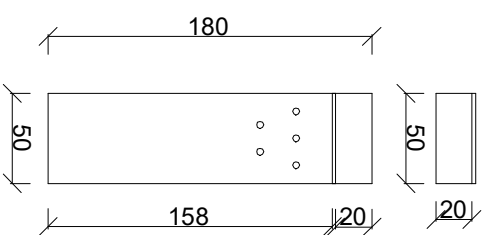

# Załącznik nr 5.4

# Szafka 2

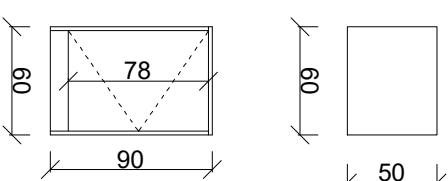

# Stolik 1

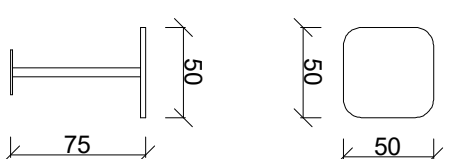

Uwaga:  
W celu dokonania dokładnych pomiarów  
niezbędna jest wizja lokalna!

# Szafa 5

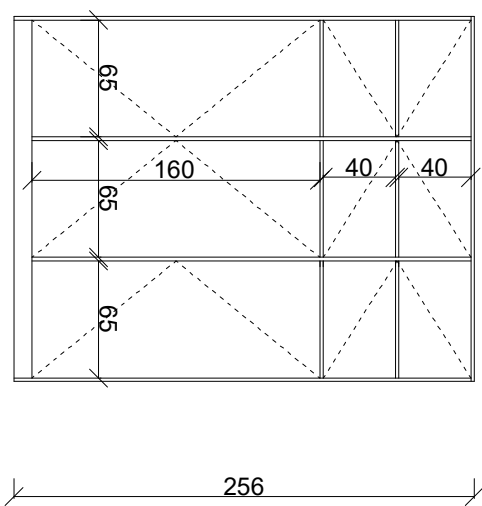

Uwaga:  
Zabudowa szafy od podłogi do sufitu

# Szafka 3

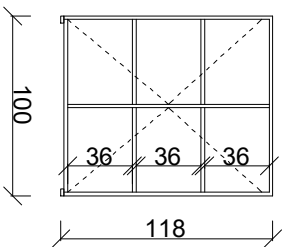
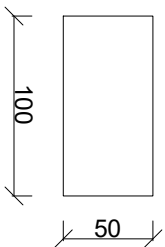

# Biurko 5

Załącznik nr 5.5

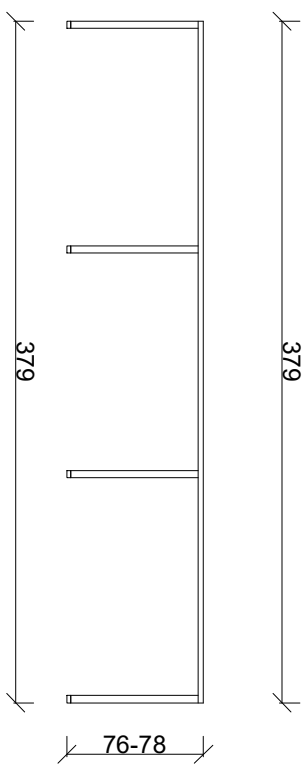
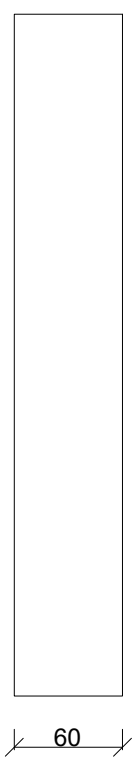

# Wieszak 2

# Kontener 2

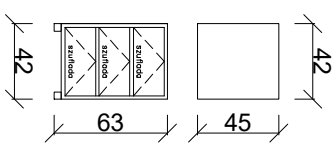
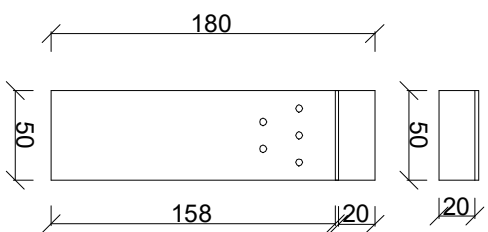

Uwaga:  
W celu dokonania dokładnych pomiarów  
niezbędna jest wizja lokalna!

# Biurko 6

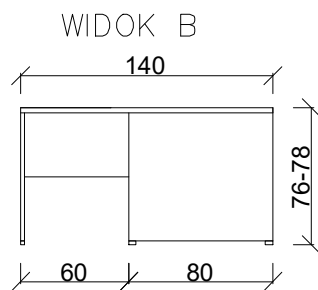
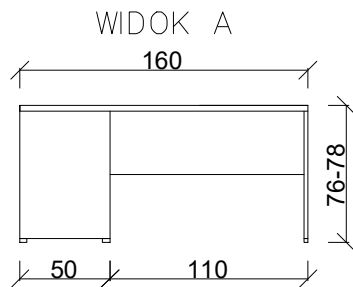
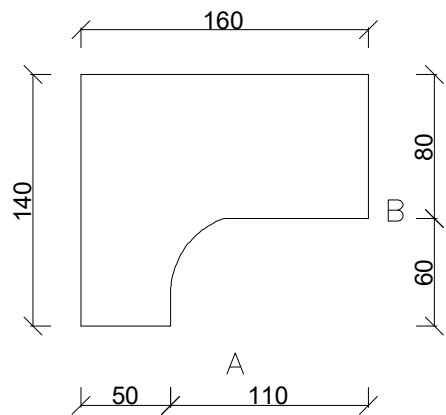

# Załącznik nr 5.6

# Biurko 7

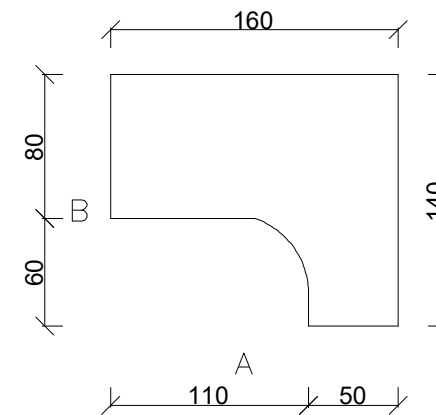
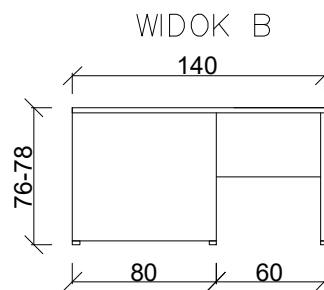
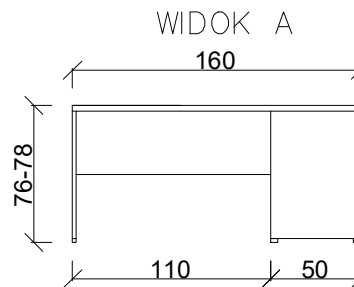

# Półka 3

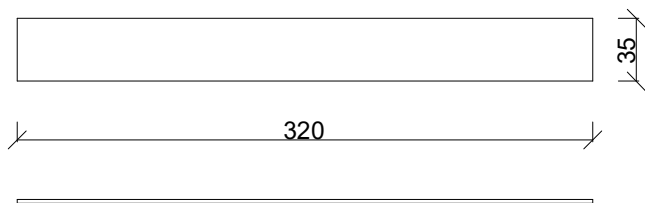

# Szafka 4

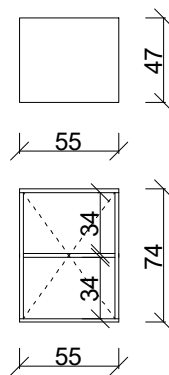

# Wieszak 3

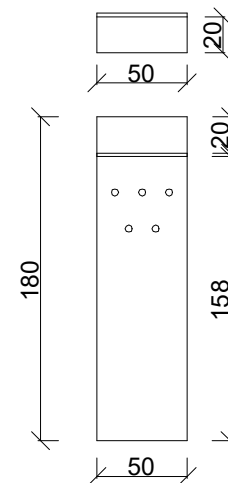

# Kontener 3

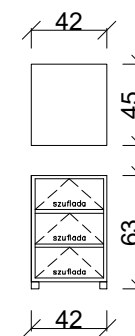

Uwaga:  
W celu dokonania dokładnych pomiarów  
niezbędna jest wizja lokalna!